

# EDN®

ELECTRONICS DESIGN NETWORK

MAR **15**  
Issue 6/2012  
[www.edn.com](http://www.edn.com)



Inside the Samsung  
40W-replacement-  
LED light Pg 22

EDN.comment Pg 10

Design Ideas Pg 42

Clamping down  
on counterfeits Pg 48

Tales from the Cube Pg 54

## HIDDEN INTERFACES

### A NEW PLAYGROUND FOR EMBEDDED INNOVATIONS

Page 32

Test-driven development for  
embedded C: Why debug?  
Page 26

Oscilloscopes and ENOB  
Page 38

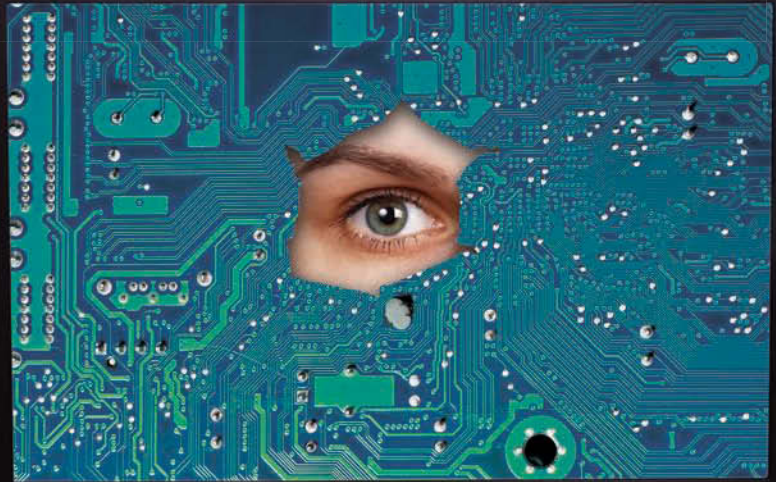

**NEW  
PRODUCTS  
ADDED DAILY**

**[DIGIKEY.COM/NEW](http://DIGIKEY.COM/NEW)**



# The World's Largest Selection

OF ELECTRONIC COMPONENTS AVAILABLE FOR IMMEDIATE SHIPMENT!



1.800.344.4539  
**DIGIKEY.COM**



2 MILLION PARTS ONLINE | 500+ INDUSTRY-LEADING SUPPLIERS | NEW PRODUCTS ADDED DAILY

Digi-Key is an authorized distributor for all supplier partners. New products added daily. © 2012 Digi-Key Corporation, 701 Brooks Ave. South, Thief River Falls, MN 56701, USA





# LAST-MINUTE CHANGES DON'T HAVE TO CHANGE EVERYTHING.

IS YOUR MCU MAKING YOUR JOB HARDER THAN IT HAS TO BE?



## Introducing Precision32™

32-bit mixed-signal MCUs engineered to make your job easier.

Tired of working late because your MCU can't easily accommodate new features or last minute design changes?

Silicon Labs' new Precision32™ mixed-signal MCUs use a patented dual-crossbar architecture that allows designers to choose peripherals and pin-out placement without worrying about pre-set limitations and pin conflicts—simplifying PCB routing, minimizing PCB layers and ultimately reducing design time and system cost.

Based on the ARM® Cortex™-M3 core, the new Precision32 SiM3U1xx and SiM3C1xx MCUs include USB and non-USB devices with 32–256 kB Flash, 8–32 kB RAM and 40–80 pin packages — all available now.

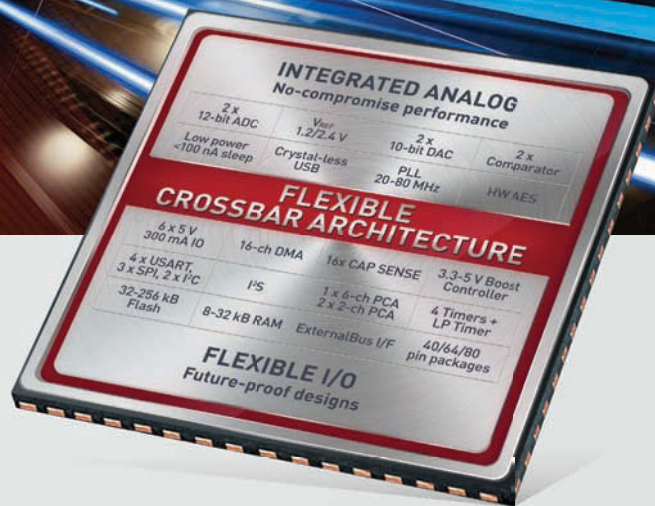

Put practically any peripheral on any pin!

Use the free Precision32 Eclipse-based IDE and AppBuilder drag-and-drop GUI to easily customize peripheral mix and pin-out placements, set up clocking modes — even generate source code!



Last minute changes? No problem.

Download white papers and data sheets, download free software tools and order hardware to start prototyping today. [www.silabs.com/32bit-MCU](http://www.silabs.com/32bit-MCU)

© 2012 Silicon Laboratories Inc. All rights reserved.

  
SILICON LABS  
Engineering for a mixed-signal world.

# Electrons prefer Coilcraft



## The path of least resistance is through our new high efficiency XAL/XFL inductors

Compared to competitive parts, current zips right through our new XAL/XFL inductors.

Their DC resistance is significantly lower than other inductors of the same size. So your batteries last longer and your power supply runs cooler.

They easily handle large peak current, and their soft saturation

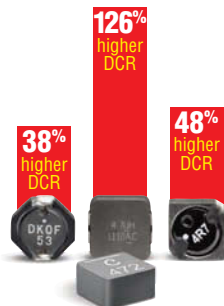

*Competitors' 4.7uH inductors have much higher DCR per mm<sup>3</sup> than Coilcraft's XAL5030.*

characteristics often let you use a smaller size part without fear of overloading during transients. Built from a uniquely formulated material, XAL/XFL parts do not have the same thermal aging problems as some competitive parts.

See all the advantages of these new high efficiency inductors. Visit [coilcraft.com/xal](http://coilcraft.com/xal).

**Coilcraft**

WWW.COILCRAFT.COM

 [coilcraftdirect.com](http://coilcraftdirect.com)  
No min order. Next day delivery.



# EDN contents

3.15.12

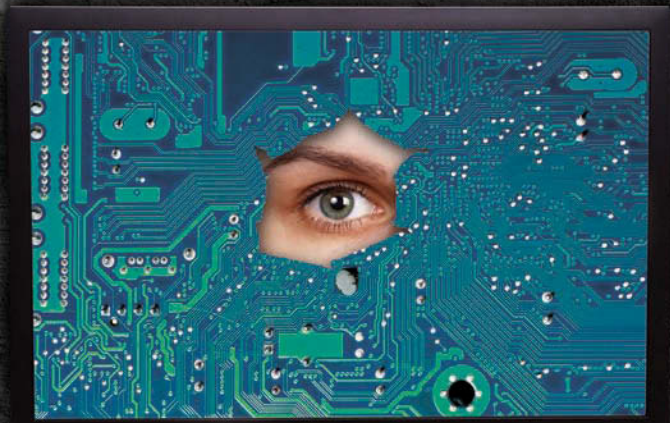

## Hidden interfaces: a new playground for embedded innovations

**32** New interfaces can detect users' presence and motion. In response, designers are providing new features to make their systems more responsive to users' needs.

*by Robert Cravotta,  
Embedded Insights Inc*

## Test-driven development for embedded C: Why debug?

**26** Test-driven development helps you improve schedule predictability and product quality by eliminating bugs before they make the bug list.

*by James W Grenning,  
Renaissance Software Consulting*

## Oscilloscopes and ENOB

**38** Selecting an oscilloscope for critical measurements requires knowledge of the quality of the scope's measurement system.

*by Joel Woodward and Brig Asay,  
Agilent Technologies*

COVER IMAGE: SHUTTERSTOCK

## DESIGN IDEAS

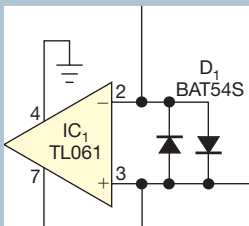

42 Condenser microphone uses dc-coupled impedance converter

43 Simple sawtooth generator operates at high frequency

46 Dual regulator handles two input voltages

► Find out how to submit your own Design Idea: <http://bit.ly/DesignIdeasGuide>.



mouser.com  
Semiconductors and electronic  
components for design engineers.

Authorized Distributor

Proof that the  
company you  
keep says a  
lot about your  
company.

Come to Mouser for what's next from these industry leaders.



mouser.com



a tti company





- 12 **Waveform analyzer plug-in smokes at 50 GHz, 32 Gbps**
- 14 **EU project boosts organic photovoltaics for solar-power generation**
- 14 **Germanium laser acts as on-chip light source**
- 16 **Chips ease users' frustration with frozen gadgets**
- 16 **Optical diode targets silicon-photonics efforts**
- 17 **Intel reveals Ivy Bridge details**
- 18 **Voices: Tensilica's Chris Rowen: hooked on electronics**

## DEPARTMENTS & COLUMNS



- 9 **EDN online:** Join the conversation; Content; Engineering Community
- 10 **EDN.comment:** EDN: It's all about you
- 20 **Baker's Best:** EMI problems? Part two: Where does EMI come from?
- 22 **Teardown:** What's inside the Samsung 40W-replacement-LED light?
- 24 **Mechatronics in Design:** Circuits without wires
- 48 **Supply Chain:** Clamping down on counterfeits
- 51 **Product Roundup:** Amplifiers and Oscillators
- 54 **Tales from the Cube:** Murphy's Law applies—even under water

EDN® (ISSN# 0012-7515) is published semimonthly by UBM Electronics, 600 Community Drive, Manhasset, NY 11030-3825. Periodicals postage paid at Manhasset, NY, and at additional mailing offices. SUBSCRIPTIONS—Free to qualified subscribers as defined on the subscription card. Rates for nonqualified subscriptions, including all issues: US, \$150 one year; \$250 two years; \$300 three years. Except for special issues where price changes are indicated, single copies are available for \$10 US and \$15 foreign. For telephone inquiries regarding subscriptions, call 847-559-7597. E-mail: edn@meda.com. CHANGE OF ADDRESS—Notices should be sent promptly to EDN, PO Box 3609, Northbrook, IL 60065-3257. Please provide old mailing label as well as new address. Allow two months for change. NOTICE—Every precaution is taken to ensure accuracy of content; however, the publishers cannot accept responsibility for the correctness of the information supplied or advertised or for any opinion expressed herein. POSTMASTER—Send address changes to EDN, PO Box 3609, Northbrook, IL 60065-3257. CANADA POST: Publications Mail Agreement 40612608. Return undeliverable Canadian addresses to APC, PO Box 503, RPO West BVR CRE, Rich Hill, ON L4B 4R6. Copyright 2012 by UBM. All rights reserved. Reproduction in whole or part without written permission is prohibited. Volume 57, Number 6 (Printed in USA).

# Benchmark MOSFETs

Small Power MOSFETs  
Designed for Handheld Devices

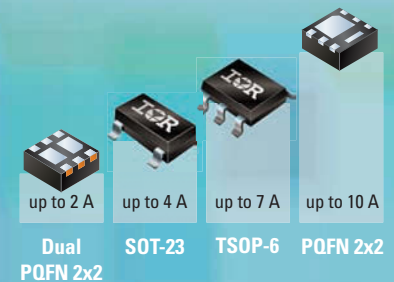

Gate Drive - 4.5V Optimized,  
2.5V Capable, 12V Maximum

BV <sub>DSS</sub>	Package	Max. R <sub>DS(on)</sub> @		Part Number
		4.5 V (mΩ)	2.5 V (mΩ)	
-20V	PQFN 2x2	31	53	IRLHS2242
	SOT-23	54	95	IRLML2244
20V	PQFN 2x2	12	16	IRLHS6242
	SOT-23	21	27	IRLML6244
	Dual PQFN 2x2	45	62	IRLHS6276
30V	PQFN 2x2	16	20	IRLHS6342
	TSOP-6	18	22	IRLTS6342
	SOT-23	29	37	IRLML6344
	Dual PQFN 2x2	63	82	IRLHS6376

### FEATURES:

- Available in both N & P Channel for simple design
- Latest silicon technology offering low R<sub>DS(on)</sub> for increased battery life
- 2.5V drive capable available for 1-cell Li-Ion Battery Applications
- PQFN package offers high power density reducing system size

For more information call 1.800.981.8699  
or visit [www.irf.com](http://www.irf.com)

International  
**IR Rectifier**  
THE POWER MANAGEMENT LEADER



Scan here to Find TI.



**mouser.com**  
Semiconductors and electronic components for design engineers.

Authorized Distributor



# Your Complete Source for Everything TI.

Over **80,000** Searchable Part Numbers. More than **100** TI Product Knowledge Centers. Find TI here. Faster at mouser.com.

 **mouser.com/ti**  
The Newest Products for Your Newest Designs®

 **TEXAS INSTRUMENTS**

**MOUSER ELECTRONICS**

a tti company





## JOIN THE CONVERSATION

Comments, thoughts, and opinions shared by *EDN's* community

In response to "Simple diode serves as a sensor for a thermal probe," a Design Idea by Raju Baddi, <http://bit.ly/AC5NIC>, Tarek comments:

"Great idea for a really cheap/bare-bones temperature sensor. It is suitable only for prototype or single shots, though ... because the exponential nature of diode IV characteristics would mean that you have to always tune the circuit. Transistors can also vary a lot, as well. Using matched pairs helps the problem only between the two on the same board, but you cannot do anything about the fact that a different pair on another board can have 50 to 100% difference in gain."

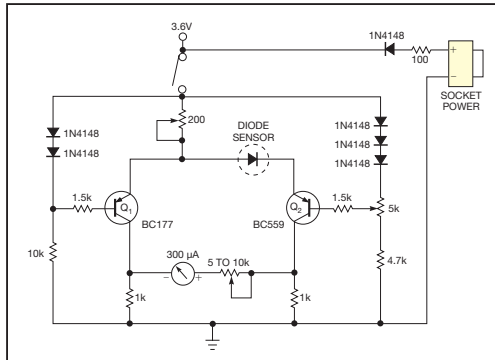

In response to "Why did you become an engineer?" a blog post by *EDN's* Suzanne Deffree, <http://bit.ly/yD1hsg>, JM Arroyo comments:

"Curiosity is the fuel of imagination, and engineering is its cure. Finding answers to what others cannot explain is magic. Since I am a lousy poet, the next best thing was becoming an engineer, especially a 'double E'; 40 years later, I still love it, and I am still searching for answers."

*EDN* invites all of its readers to constructively and creatively comment on our content. You'll find the opportunity to do so at the bottom of each article and blog post. To review current comment threads on *EDN.com*, visit [http://bit.ly/EDN\\_Talkback](http://bit.ly/EDN_Talkback).



## CONTENT

Can't-miss content on *EDN.com*

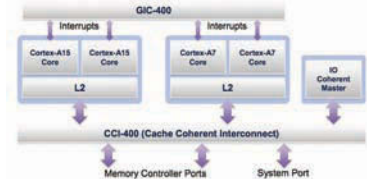

### GETTING AROUND MULTICORE WALLS: THE ROADS LESS TRAVELED

The processor industry has been running pell-mell down the road of multicore design. But a funny thing happened on the way to the personal supercomputer: It didn't work.

<http://bit.ly/yJv5UB>

### ATMEL AND CYPRESS TARGET SINGLE-LAYER TOUCHSCREENS WITH NEW CONTROLLERS, ITO SENSOR



Single-layer, multitouch touchscreens are getting thinner, smarter, and less

expensive. Meanwhile, physical knobs and switches are going the way of the dinosaurs.

<http://bit.ly/zLCu1m>



## ENGINEERING COMMUNITY

Opportunities to get involved and show your smarts

### Engineering the Next Generation networking event

Remember when you were just starting out and a more experienced engineer took you under his wing, helped you navigate those first few years of your career, and always had from-the-field words of wisdom to share? It's time to be that guy. Join us on March 28, during Design West, at a networking event for experienced engineers and new engineering professionals. You'll get the chance to meet the next generation, offer your mentorship if you choose to, and get an idea of who will be sitting in your chair in 10, 20, or 30 years. Find information and register at <http://bit.ly/zDFaGF>.





BY PATRICK MANNION, DIRECTOR OF CONTENT

## EDN: It's all about you

Change is the one true constant, and *EDN* is no exception. In the coming weeks, you'll be hearing and seeing more and more how *EDN.com* is also changing. In fact, you've already seen some of those changes reflected in the print edition of *EDN*, specifically in the content that emphasizes the comments you've made online about our articles. Those changes represent minor tweaks to our print edition, but they're symbolic of a key underlying principle of *EDN* and our site redesign: It's all about you, the engineer. *EDN* has always been about you and helping you understand the latest trends and technologies and how to fold them into your next design. That goal hasn't changed and won't change.

We are changing how we achieve this goal, however. To date, it's been a bit of a one-way conversation. We typically scout the horizon and bring back the latest and greatest in a form that you can quickly digest and use. That approach is good, but, with the new site, we'll make it a lot easier for you to provide your feedback to us and to the world by placing that feedback farther up on each page and within each article. Your voice, the voice of the engineer, will ring loud and clear.

We'll also make it much easier for you to directly contribute to the conversations through article-upload pages for feature articles; Design Ideas; Tales from the Cube; products; and, eventually, video you'd like to share. From reading the many comments you leave on our site, it's clear that you have a lot of opinions and ideas, and it's our goal to put a spotlight on those thoughts and foster discussion and conversation about them to help you connect with your peers, find like-minded engineers, and as quickly as possible get your design from concept to reality.

Are you social? That question has been asked of engineers more than most other groups because we tend to be



**Social media for engineers: not an oxymoron, especially if it can help you get home at a decent time on a Friday night.**

introverted, and people perceive us as a tough bunch to engage with. Not all of us fit that mold, but it's a general rule of

thumb. We're also skeptical of the next big thing, avoid marketing types like the plague, and generally don't trust sales or anyone hawking a cure-all—in other words, we're viewed as scarily smart.

For these reasons, it seems, we're less likely to jump on the social-media bandwagon. When we do enter the fray, though, we want to look at how to reinvent the tools and platforms. We can't help ourselves.

Me? I have two Facebook accounts. Neither has my true date of birth or age. I don't trust Facebook's policies and security systems. Yet, although I was slow to join Facebook, I've found it a useful way to keep up with friends in the industry whom I'd otherwise be unable to keep track of on a regular basis. When they, as well as my boss and colleagues, recently sent me a happy-birthday note during the Consumer Electronics Show, I was grateful and didn't want to break the news to them that it's not until, well, some other time later in the year.

This information is now relevant because *EDN* will be implementing a type of social media. It's not personal, and it focuses entirely on helping you keep track of what's going on across the site and keeping track of those contributors you like and the topics you enjoy. This social media for engineers targets those who want the knowledge, information, and contacts to help them network with peers and still be able to get home at a decent time on a Friday night. The idea is to be nonintrusive but helpful. Combining that goal with the content we'll be posting across the site, we hope you'll have a bit of fun in the process.

What do *you* want to see on *EDN.com* and in *EDN*? It's your outlet, both online and print, so where do you want to take it? We have ideas aplenty based on your feedback over the years, but the changes afoot make it even more important that you tell us what you need and what you'd like to see. We're looking forward to hearing from you! **EDN**

Contact me at [patrick.mannion@ubm.com](mailto:patrick.mannion@ubm.com).



**SENIOR VICE PRESIDENT,  
UBM ELECTRONICS**

David Blaza  
1-415-947-6929;  
david.blaza@ubm.com

**DIRECTOR OF CONTENT,  
EDN AND DESIGNLINES**

Patrick Mannion  
1-631-543-0445;  
patrick.mannion@ubm.com

**EXECUTIVE EDITOR,  
EDN AND DESIGNLINES**

Rich Pell  
*Consumer*  
1-516-474-9568;  
rich.pell@ubm.com

**MANAGING EDITOR**

Amy Norcross  
*Contributed technical articles*  
1-781-869-7971;  
amy.norcross@ubm.com

**MANAGING EDITOR, ONLINE**

Suzanne Deffree  
*Electronic Business, Distribution*  
1-631-266-3433;  
suzanne.deffree@ubm.com

**SENIOR TECHNICAL EDITOR**

Margery Conner  
*Design Ideas, Power Sources,  
Components, Green Engineering*  
1-805-461-8242;  
margery.conner@ubm.com

**SENIOR TECHNICAL EDITOR**

Steve Taranovich  
*Analog, Systems Design*  
1-631-413-1834;  
steve.taranovich@ubm.com

**DESIGN IDEAS  
CONTRIBUTING EDITOR**

Glen Chenier  
edndesignideas@ubm.com

**SENIOR ASSOCIATE EDITOR**

Frances T Granville, 1-781-869-7969;  
frances.granville@ubm.com

**ASSOCIATE EDITOR**

Jessica MacNeil, 1-781-869-7983;  
jessica.macneil@ubm.com

**COLUMNISTS**

Howard Johnson, PhD, Signal Consulting  
Bonnie Baker, Texas Instruments  
Pallab Chatterjee, SiliconMap  
Kevin C Craig, PhD, Marquette University

**CONTRIBUTING TECHNICAL EDITORS**

Dan Strassberg, strassbergedn@att.net  
Brian Bailey, brian\_bailey@acm.org  
Robert Cravotta,  
robert.cravotta@embeddedinsights.com

**VICE PRESIDENT/DESIGN DIRECTOR**

Gene Fedele

**CREATIVE DIRECTOR**

David Nicastrò

**ART DIRECTOR**

Giulia Fini-Gulotta

**PRODUCTION**

Adeline Cannone, Production Manager  
Laura Alvino, Production Artist  
Yoshihide Hohokabe, Production Artist  
Diane Malone, Production Artist

**EDN EUROPE**

Graham Prophet  
Editor, Reed Publishing  
gprophet@reedbusiness.fr

**EDN ASIA**

Huang Hua  
Operations General Manager  
huang.hua@ednasia.com  
Grace Wu  
Associate Publisher  
grace.wu@ednasia.com  
Vivek Nanda, Executive Editor  
vnanda@globalsources.com

**EDN CHINA**

Huang Hua  
Operations General Manager  
huang.hua@ednchina.com  
Grace Wu  
Associate Publisher  
grace.wu@ednasia.com  
Jeff Lu, Executive Editor  
jeff.lu@ednchina.com

**EDN JAPAN**

Masaya Ishida, Publisher  
mishida@mx.itmedia.co.jp  
Makoto Nishisaka, Editor  
mnishisa@mx.itmedia.co.jp

**UBM ELECTRONICS  
MANAGEMENT TEAM**

Paul Miller, Chief Executive Officer,  
UBM Electronics, UBM Canon (Publishing),  
UBM Channel, and UBM Design Central  
Kathy Astromoff,  
Chief Executive Officer, UBM Electronics  
Brent Pearson,  
Chief Information Officer  
David Blaza,  
Senior Vice President  
Karen Field,  
Senior Vice President, Content  
Jean-Marie Enjuto,  
Vice President, Finance  
Barbara Couchois,  
Vice President, Partner Services  
and Operations  
Felicia Hamerman,  
Vice President, Marketing  
Amandeep Sandhu,  
Director of Audience Engagement  
and Analytics

# PICO

**AC-DC Converters  
Power Factor Corrected**

**5-300Vdc**

**Isolated DC Output**

**Low Cost  
Industrial**

**UP TO  
300  
WATTS**

**Two Units in One  
AC1 Series**

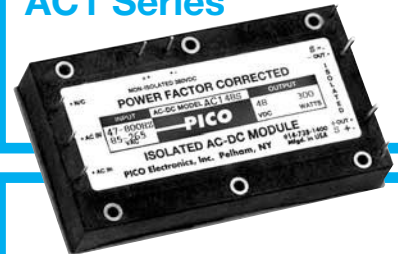

**Universal AC Input  
47-400Hz  
Input Frequency**

- **STANDARD:** 5 to 300 vdc regulated, ISOLATED outputs/Fixed frequency
- **ALL in ONE** compact full brick module, 2.5" x 4.6" x 0.8" Vacuum encapsulated for use in rugged environments
- **Lower cost for your Industrial applications**
- **Maximize your design up to 300 watt models**
- **Meets Harmonic Distortion specifications**
- **.99 Power factor rating at operational levels**
- **Expanded operating temperatures available -40 & -55C, +85 & 100C base plate**
- **Custom models available**

[www.picoelectronics.com](http://www.picoelectronics.com)

Send Direct  
for free PICO Catalog

E-Mail: [info@picoelectronics.com](mailto:info@picoelectronics.com)

**PICO Electronics, Inc.**

143 Sparks Ave, Pelham, NY 10803-1837

Call Toll Free 800-431-1064 • FAX 914-738-8225



For a complete list of editorial contacts,  
see <http://ubmelectronics.com/editorial-contacts>

# pulse

INNOVATIONS & INNOVATORS

## Waveform analyzer plug-in smokes at 50 GHz, 32 Gbps

Leading-edge optical- and electronic-communication-system design is difficult. You need consistent and confidence-inspiring instrumentation that has better than the leading-edge performance you are trying to achieve. Meeting these requirements, the 86108B precision waveform-analyzer module from Agilent, part of the company's 86100C/D DCA wide-bandwidth-oscilloscope family, targets the testing of high-speed links, such as IEEE 802.3ba 40/100-GbE, Optical Internetworking Forum CEI 3.0, and Fibre Channel INCITS T-11 32G.

Its integrated precision timebase and clock-recovery design yields typical residual jitter of less than 50 fsec rms for the high-bandwidth option and provides continuous data-rate coverage from 50 Mbps to 32 Gbps, along with peaking control and adjustable loop bandwidths to 20 MHz for enhanced phase-locked-loop response. The internal triggering architecture allows relatively simple connection schemes, along with analysis of low-

amplitude signals and elimination of clock-data delay that can corrupt jitter measurements. An internal phase detector supports accurate measurements of PLL bandwidth, jitter transfer, and jitter- and phase-noise spectrum.

The low-bandwidth option offers two channels with 35-GHz bandwidth; residual jitter of less than 60 fsec/90 fsec; typical and guaranteed noise of 500 and 700  $\mu$ V, respectively; and internal clock-recovery rates of 50 Mbps to 16 Gbps or 50 Mbps to 32 Gbps, depending on option. The high-bandwidth option instrument's bandwidth is 50 GHz, with jitter specifications of 50 fsec/70 fsec; typical guaranteed noise of 800 and 980  $\mu$ V, respectively; and the same clock-recovery rates as the low-bandwidth option. Prices start at \$80,000.

—by Bill Schweber

► **Agilent Technologies,**  
[www.agilent.com/find/86108B](http://www.agilent.com/find/86108B),  
[www.agilent.com/find/dcax](http://www.agilent.com/find/dcax).

### TALKBACK

**“Always learn as much as possible about a problem before trying to find a solution to save yourself a lot of unnecessary work and possibly even from finding the wrong solution. Kinda reminds me of the Health Reform debacle going on in Congress these days.”**

—Electrical engineer Lee Hardesty, in *EDN's* Talkback section, at <http://bit.ly/y4hykJ>. Add your comments.

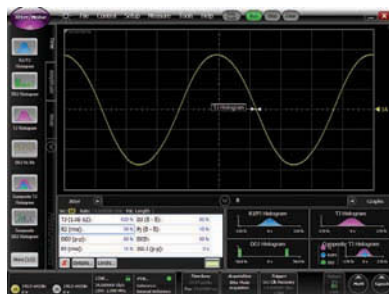

A jitter measurement of a 14-GHz sine wave shows that the RJ component measures at 39 fsec rms, using the module's integrated clock-recovery and timebase functions.



The Agilent 86108B precision waveform analyzer's plug-in module for the 86100C/D DCA wide-bandwidth-oscilloscope family targets the testing of high-speed links.



**Name**

*Dr. Dave Barrett*

**Job Title**

*Professor,  
Mechanical Engineering*

**Area of Expertise**

*Robotics*

**LabVIEW Helped Me**

*Bridge the gap between  
teaching theory and real-  
world design experience*

**Latest Project**

*Building a robotic tuna  
to swim across  
the Atlantic Ocean*

NI LabVIEW

LabVIEW makes me better by making complex

# CONTROL

simple and accessible

>> Find out how LabVIEW can make you better at [ni.com/labview/better](http://ni.com/labview/better)

800 453 6202



## EU project boosts organic photovoltaics for solar-power generation

**C**SEM (Swiss Center for Electronics and Microtechnology) has launched a four-year, €14.2 million (\$18.8 million) project that aims to develop highly efficient, long-lasting, inexpensive, and environmentally friendly printed organic photovoltaics. The Sunflower (sustainable novel flexible organic watts efficiently reliable) project gathers 17 partner institutions from science and industry, including Agfa, BASF, DuPont Teijin Films, and Amcor Flexible Kreuzlingen, as well as photovoltaic pioneer Konarka Technologies and European research institutes and universities.

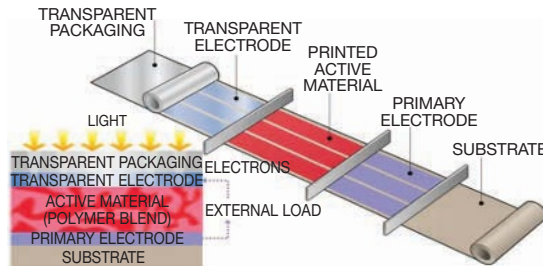

The requirements for the Sunflower-project prototype include high module efficiency, multilayer structures, cost-effective barriers, and roll-to-roll atmospheric-printing processes.

The Sunflower consortium expects to produce printed organic photovoltaic panels with high-efficiency architectures, such as tandem cells and dedicated light-management structures. The performance of

the photovoltaics' active- and passive-barrier materials will greatly increase and will include process-controlled morphology, according to the partners. They intend to deliver products for cost-effective flexible sub-

strates, diffusion barriers, and conductors. They also expect to soon have a deeper knowledge of the device physics, an elucidation of degradation mechanisms, and an estimate of the environmental impact of the main materials and processes.

According to the consortium, the requirements for the project prototype include high module efficiency that will compete with other photovoltaic technologies; multilayer, or tandem, structures to achieve high efficiency; cost-effective barriers to achieve long lifetime; and roll-to-roll atmospheric-printing processes to lower costs in situations in which costs include fabrication and environmental impact.

—by Anne-Françoise Pele  
 ▶ CSEM, [www.csem.ch](http://www.csem.ch).

## Germanium laser acts as on-chip light source

**A**PIC (Advanced Photonic Integrated Circuits) Corp, a supplier of photonic ICs to the US military, has announced that a research team under the leadership of APIC Chairman and Chief Executive Officer Birendra “Raj” Dutt has succeeded in getting germanium to act as a laser. This achievement opens the prospect of using germanium as an on-chip light source for a future generation of silicon-based

photonic ICs, the company says. Allowing circuits to use light instead of electrons could result in higher-performance ICs that consume less power.

Acting as principal investigator, Dutt led a team of researchers at the Massachusetts Institute of Technology, Stanford University, and APIC to achieve the research result. APIC does not indicate how it accomplished the task of making a germanium laser or the wavelength

of the photons the laser emits. Germanium is compatible with conventional silicon manufacturing and finds use in silicon-germanium-process technology to improve electronic circuits, enabling a relatively easy transition from electronics to photonics. Ultimately, both data and control circuits could be photonic, and one circuit that could benefit from on-chip optics would be an optical clocking circuit. Optical processing, which manufacturers sometimes perform using lenses to process data fields, also readily supports

parallel processing. Photonic chips would use a fraction of the power electronic circuits now need, with the beneficial effect that much of the cooling plant and energy expenditure associated with computers and data centers could also become unnecessary.

APIC has teamed with the College of Nanoscale Science and Engineering in New York State, with a plan to within two years produce a fully manufacturable photonic chip using the technology. “We will now be able to use photons for many of the information functions that electrons have performed on silicon computer chips, drastically reducing their power consumption [and] supercharging performance,” says Dutt. “Photonics is naturally ‘green.’ Along with the energy savings, optical-data-communications networks provide massive increases in processor speed and computational capabilities.”

—by Peter Clarke  
 ▶ APIC, [www.apichip.com](http://www.apichip.com).

### DILBERT By Scott Adams

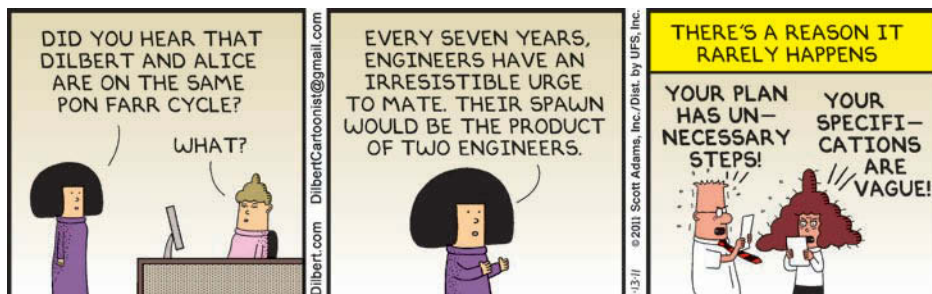



# Rarely Asked Questions

Strange stories from the call logs of Analog Devices

## Nobody is Perfect – Not Even an Engineer!

**Q.** What is the most common problem with precision analog circuits?

**A.** Probably grounding errors, but there are a number of frequently seen mistakes. They are mostly sins of omission; engineers are not perfect and can forget things.

1. Don't forget to read the data sheet. (Application engineers routinely shout "RTFDS"<sup>1</sup> as they hang up after an enquiry.) Extracting implicit information from a data sheet, not just the explicit details, is important.
2. Don't forget Ohm's Law. The resistance of a wire or PC track is not zero, and leakage in "insulators" matters when measuring low currents.
3. Don't forget the bias current. Sometimes greasy fingerprints provide a current path in the prototype, leading to surprises in the clean(er) final version.
4. Don't forget the stray resistances, inductances, and capacitances of the final (crowded) PCB; don't assume that all is well because the breadboard (or the SPICE model) worked.
5. Don't forget that EMI and RFI occur everywhere; filter your supplies and input/output leads.
6. Don't forget to consider the effects of temperature variation on components (including the effects of differing temperature coefficients in nominally identical components).
7. Don't forget to verify that the circuit can tolerate having its supplies (and signals) applied in any order (and with any value of  $dv/dt$ )—or to ensure that it cannot be exposed to unacceptable power/signal sequences and rates.
8. Don't forget that switching power supplies are not as noise free as a battery.
9. Don't forget that analog circuits, unlike microprocessors, often do not reset on power up and that you may need to ensure correct start-up.
10. Don't forget that circuits don't start instantly: capacitors must charge and precision circuits must stabilize.
11. Don't forget that some circuits are unstable when driving a reactive load. An output stage that will drive a wide range of resistive loads may oscillate with capacitance, such as that of a cable.
12. Don't forget that noise, like death and taxes, is universal. Every ADC has quantization noise, every resistor has Johnson noise—you can't avoid them.
13. Don't forget that IC designers may not be user friendly. Devices may not work as you expect. Again I say, "RTFDS!"



All these issues, and more, have been discussed in earlier columns. Read them all, and pin up this list where you can read it every day!

**To Learn More About  
Precision Analog Circuits**

<http://dn.hotims.com/40996-100>



**Contributing Writer**  
**James Bryant has been a European Applications Manager with Analog Devices since 1982. He holds a degree in Physics and Philosophy from the University of Leeds. He is also C.Eng., Eur. Eng., MIEE, and an FBIS. In addition to his passion for engineering, James is a radio ham and holds the call sign G4CLF.**

**Have a question involving a perplexing or unusual analog problem? Submit your question to: [www.analog.com/askjames](http://www.analog.com/askjames)**

For Analog Devices' Technical Support, Call 800-AnalogD

SPONSORED BY



<sup>1</sup>RTFDS = "Read The Friendly Data Sheet"

## Chips ease users' frustration with frozen gadgets

STMicroelectronics' new generation of smart-reset chips provide a safe, convenient, and intuitive means of resetting "frozen" gadgets, such as mobile phones, media players, and other portable consumer devices. Traditionally, when electronic devices freeze or lock up, users either try to remove the battery, which is sometimes inconvenient, or find an appropriate tool to press the dedicated reset button, which is typically in a hole that is often difficult to access.

Smart resets extend the functional capability of a device's buttons so that users can simply reset their frozen device by simultaneously pushing one or two buttons for a long time. With the increasing popularity of touchscreen devices, smart resets remove the need for extra buttons, sav-

ing space and cost for equipment manufacturers and significantly increasing convenience for the user.

"The proliferation and complexity of mobile apps, operating-system versions, and hardware platforms has inevitably brought about interoperability issues, with consumers increasingly experiencing frozen operation, or the 'white screen of death,' on their portable devices," says Alberto De Marco, director of the standard and high-resolution-products business unit at STMicro.

The STM6524 dual-assert, smart-reset IC effectively prevents accidental resets. Its two inputs connect to a selected pair of buttons on an electronic gadget. When a user holds these buttons simultaneously for a manufacturer-specified time, the IC sends a reset sig-



STMicro's smart-reset chips provide a safe, convenient, and intuitive means of resetting frozen gadgets, such as mobile phones, media players, and other portable consumer devices.

nal to the main processor. The combination of two inputs and a programmable delay time effectively prevents accidental resets. The new single-assert STM6519 smart-reset IC targets single-button electronic devices, such as tablets and e-readers, with a programmable-delay reset.

The IC has a smaller package than other currently available devices, and it implements a customizable extended input delay of 0.5 to 10 sec,

which increases flexibility and enables manufacturers to distinguish their products through user-interface settings. The smart resets also integrate a dedicated test mode, which improves device testability and slashes test costs. The STM6519 and STM6524 sell for \$0.242 and \$0.338 (1000), respectively.

—by Fran Granville  
 ▶STMicroelectronics, www.st.com.

## Optical diode targets silicon-photonics efforts

The Massachusetts Institute of Technology recently demonstrated a thin-film optical diode that designers can integrate onto a silicon photonic chip along with lasers and waveguides. This task previously required a separate, discrete device. According to Caroline Ross, the device's creator and the Toyota professor of materials science and engineering at MIT, the device creates a one-way street for photons in the same way an electric diode directs a current flow in only one direction. Optical diodes will be useful for future photonic chips that would eliminate the need for translating optical into electrical signals and back again to perform switching and signal-processing functions (Reference 1).

Using a garnet material, which has a different index of refraction depending on which way light is flowing through it, MIT researchers demonstrated the passing of optical signals in one direction. The signals then divert into a loop when traveling in the opposite



Caroline Ross, the Toyota professor of materials science and engineering at MIT, created a thin-film optical diode that designers can integrate onto a silicon photonic chip (courtesy Allegra Boverman, MIT).

direction. Garnet, a material that is both transparent and magnetic, is more difficult than silicon to fabricate on CMOS chips. Nevertheless, Ross and her colleagues demonstrated that they could deposit thin films of garnet on silicon using standard processing steps.

The new component is a "diode for light," according to Ross. Manufacturers could build the system using standard microchip-manufacturing machinery. "It simpli-

fies making an all-optical chip," she says. The fact that manufacturers can now make an integrated optical circuit could make the technology easier to commercialize than a system using different materials, explains Ross, who says that manufacturers should want to use a silicon platform.

"There's a huge infrastructure for silicon processing," she adds. "Everyone knows how to process silicon. That [knowledge] means that they can ... develop the chip without having to worry about new fabrication techniques." —by R Colin Johnson  
 ▶MIT, www.mit.edu.

### REFERENCE

1 Bi, Lei; Juejun Hu; Peng Jiang; Dong Hun Kim; Gerald F Dionne; Lionel C Kimerling; and Caroline A Ross, "On-chip optical isolation in monolithically integrated non-reciprocal optical resonators," *Nature Photonics*, November 2011, pg 758, <http://bit.ly/zRXSp4>.



## INTEL REVEALS IVY BRIDGE DETAILS

Intel recently gave the first public look at Ivy Bridge, the first processors to use the company's 22-nm trigate technology. Intel plans at least four major variants of the chip, which packs 1.4 billion transistors into 160 mm<sup>2</sup> in its largest version. Ivy Bridge includes 20 channels of PCIe Generation 3 interconnect and a DisplayPort controller.

The first Ivy Bridge chip, with as much as 8 Mbytes of cache memory, targets a range of desktop, notebook, embedded, and single-socket server systems. It integrates a memory controller and graphics, which now support DDR3L DRAMs and Microsoft DirectX 11.0 graphics APIs.

The largest die includes four x86 cores and a large graphics block. Designers can chop it along its X axis, its Y axis, or both using automated generation tools to create versions with two cores or a smaller graphics block.

Ivy Bridge handles as many as 1600 million transfers/sec as well as 1.5V DDR3. A write-assist cache circuit provides an average power reduction of 100 mV. The DisplayPort block supports three displays, including one 1.6-GHz and two 2.7-GHz links.

—by Rick Merritt

► Intel, [www.intel.com](http://www.intel.com).

03.15.12

# Embedding Wireless Just Got a Whole Lot Easier



*And Faster, and Smaller,  
and Less Expensive . . .*

**. . . YET PACKING  
MORE RELIABILITY  
AND FEATURES**

- 2.4GHz Frequency Hopping Spread Spectrum Performance
- FCC, Canadian IC and ETSI Pre-Certified
- RF Data Rate of 250 kb/s
- Multiple analog, digital, UART and SPI interfaces
- Battery operation supporting sleep mode and Auto-Reporting
- No programming or co-processor needed
- U.FL and Chip Antenna versions available
- Developer Kits Available



**DNT24**  
**\$29**  
Qty of 1

<http://www.rfm.com/>



**Click here to find out  
how RFM's pre-certified**

modules can deliver reliable wireless for your **residential, commercial, industrial, and agricultural** applications in a fraction of the time, at a fraction of the cost, and with a fraction of the hassle.

**Where to Buy:**  
- Avnet Memece  
- Digi-Key  
- Future Electronics  
- Mouser Electronics

## VOICES

### Tensilica's Chris Rowen: hooked on electronics

Chris Rowen, PhD, the first president of Tensilica Inc, is the company's founder, chief technology officer, and a member of the board. Rowen in 1984 helped start MIPS Computer Systems Inc and most recently was vice president and general manager of the Design Reuse Group at Synopsys. The RISC guru spoke with *EDN* about how he became interested in engineering, what engineering students need to know, and the biggest challenges facing SOC design for today's advanced applications. A portion of that interview follows. Read the full version at [www.edn.com/120315pulsea](http://www.edn.com/120315pulsea).

#### How did you initially become interested in engineering?

**A** I was a physics major as an undergraduate. Physics was great: It was tough and theoretical. But in my junior year, I took a laboratory electronics class for physicists, with the idea being you've got to go build some of the equipment you're going to use to be a practicing physicist. It was just such an eye opener; there was all this cool stuff that you could do. It was basically the TTL of design: logic gates, counters, resistors, capacitors, and inductors—the basic stuff. It was both an introduction to all of the standard electronics theory, but also very hands-on. I was hooked.

Then the hook was sunk in deep because I was working on advanced DRAM technology and stuff. I went to work for Intel when I got my degree in physics and got deeply involved in transistors, in layout, and in all the issues around fundamental electronics and logic design, then programming testers to test semiconductor devices.

#### What advice would you give to engineering students today about the challenges they are going to face to help them prepare for the realities of a career in engineering?

**A** One of them is understand the whole technology stack, meaning understand something about transistors, gates, processor architecture, parallelism, networks, large data, large systems, and applications because you really want to find the places where you can connect between levels; that's where the most valuable insights come from. Lots of specialists know all about transistors or all about social networking or all about microprocessor instruction sets, but you can't typically push one level alone. It's when you understand something about where the end applications are pulling you or where the underlying electronic technology is pushing you that you get to do something outside the box. Understanding the whole technology stack and how you make tradeoffs between levels is an essential capability for people who



want to be real innovators.

The second thing is work on hard problems rather than popular problems. Popularity of problems comes and goes; they're fads, particularly if you've been in venture-funded things. The venture community tends to wake up one day and say, "It's all social networking!" or "It's all graphics!" Everybody then rushes into the space, and even companies with superior technology can get lost in the noise of the other 47 companies trying to do the same thing because it's a fad. On the other hand, if you're working on hard problems, then you have a chance of doing something that's defensible, and you have a chance of doing something that's more durable than the current funding cycle.

The last one is I think true of every field: Seek out the best people; work for the best people. Judge what you work on not by how hot it is at the moment or even how lucrative it looks like it's going to be but who's going to be able to share their insights, their brilliance, their observations, and their connections with you because so much of what you learn is not the kind of knowledge you're going to get from the text books or knowing the theory better than somebody else,

although [those things] certainly help. It's going to be what models of behavior you learn and what intellectual disciplines you develop; the role of mentor is very important in [achieving those goals]. Sometimes, it is your peers who are your mentors on particular dimensions of a problem.

#### What is the biggest challenge facing the business of SOC design for advanced applications?

**A** We happen to be doing it with this notion of the application-specific data processor. But the bigger problem we're addressing is: How do we take all of this hypothetical capability in deep-submicron technology—28 and 22 nm? You can build these chips with a billion transistors and turn it into something that's an efficient and unique world-changer in that particular segment. Then, do that [scenario] over and over again in the hundred different subsegments where people build electronics. All these smartphone categories and digital-television categories and home-network categories are enabling simultaneous innovation by teams with different skills. How do we engender and encourage the sort of creativity that can create new leaders in each of these segments?

It's sometimes a question of helping people overcome their own self-doubts. You keep solving the same problems or the new problems in the same way. That [approach] sometimes makes it hard to get ahead, to innovate, to do things that haven't been done before. [It] fails to take advantage of changes that are taking place and fails to bridge between these levels of the technology stack. —interview conducted and edited by Ann Steffora Mutschler



# Welcome to the mobile age of data monitoring and control.



The Agilent 34972A Data Acquisition Switch Unit takes our best-selling Agilent 34970A to the next level with built-in LAN and USB connectivity. You can even control everything remotely via mobile Web interface (phone or tablet). So you can collect and understand more data, more quickly.

34972A	34970A
BenchLink data logger software SCPI programming	
3-slot LXI unit with built-in 6½ digit DMM	
USB and LAN	GPIB and RS-232
Graphical web interface	N/A
\$1,845*	\$1,597*

\* Prices are in USD and are subject to change

Scan the QR code or visit <http://goo.gl/nELPY> to see a 34972A product tour video



**Agilent and our  
Distributor Network**  
Right Instrument.  
Right Expertise.  
Delivered Right Now.



866-436-0887  
[www.metrictest.com/agilent](http://www.metrictest.com/agilent)

**FREE mobile app and wireless  
connectivity measurement tips**  
[www.metrictest.com/agilent/daq.jsp](http://www.metrictest.com/agilent/daq.jsp)

© 2012 Agilent Technologies, Inc.

Anticipate — Accelerate — Achieve



**Agilent Technologies**



BY BONNIE BAKER



## EMI problems? Part two: Where does EMI come from?

**E**lectromagnetic interference is a part of our lives. Many people think that the proliferation of electronic products is a good thing because they improve our comfort, safety, and health (Reference 1). These products also bring with them the potential for electronically harmful EMI signals. EMI signals can come from various sources, including the common electronic devices around us, as well as vehicles and heavy equipment. In automotive designs, some of these EMI generators reside in the same cabinet as the vehicles' sensitive electronic circuits. This proximity affects the audio equipment, automatic door controls, and other equipment.

Every electronic device, including cell phones, creates both good and bad characteristics. Cell phones these days offer the convenience of talking to friends, family, and business associates from just about anywhere. However, they also have the potential to produce EMI signals—and those signals are only part of the problem. The evolution of these devices exceeds the basic phone services by including smartphone capabilities.

Neighboring equipment and circuits do not expect this type of EMI noise. Cell phones rely on high levels of RF energy to do their jobs. Although they comply with regulations, they may become sources of

unintended EMI to susceptible devices.

PCBs, clock circuits, oscillators, digital circuits, and processors also can be sources of EMI in circuits. Electromechanical devices that switch currents produce EMI during make-or-break operations. These EMI signals do not necessarily have a negative effect on other electronic equipment. The spectral content and intensity of an EMI signal determine whether it has the potential for an unexpected response from a susceptible circuit.

You can simplify the spectral content of a digital signal to its frequency and rise time. The clock or system frequency establishes a time reference for the cir-

cuit, but its edge rates create interfering harmonics. **Figure 1** shows the spectral content of a 10-MHz square wave. The 10-MHz signal has an edge rate of 10 nsec. The magnitude of these harmonics decreases with frequency. Generally, the potential EMI for this type of signal spans to the maximum frequency, or  $1/(\pi \times t_{\text{RISE}})$ , where  $t_{\text{RISE}}$  is the rise time, equating to approximately 31.8 MHz for a 10-nsec edge rate.

The **figure** shows that the last significant harmonic occurs at 30 MHz. Meanwhile, the 1-nsec edge rate in **Figure 2** equates to a maximum frequency of 318 MHz. The EMI harmonics might cause interference in your circuit if it is susceptible to frequencies within the 318-MHz bandwidth.

It is better to stop the interfering signal at its source, rather than allow it to propagate through circuits. As for vehicles, carmakers are constructing more vehicle bodies with plastic, which becomes a problem when you need to find a low-impedance ground or provide shielding.

Once the signals are free and roaming about, they stand a chance of entering your sensitive systems and wreaking havoc. Next month's column will detail how the EMI signal travels through the medium to get to your circuits. **EDN**

### REFERENCE

1 Baker, Bonnie, "EMI problems? Just the facts, please," *EDN*, Feb 16, 2012, pg 18, <http://bit.ly/x8ue6u>.

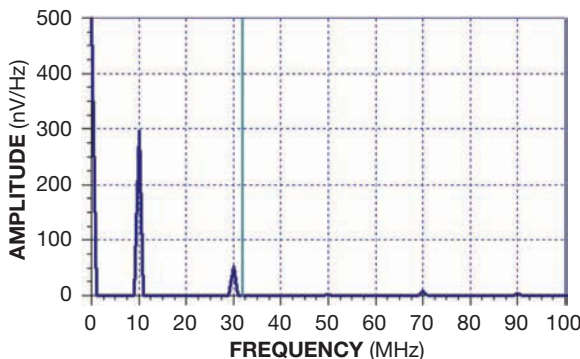

**Figure 1** The spectral content of a 10-MHz square wave shows that the 10-MHz signal has an edge rate of 10 nsec. The magnitude of these harmonics decreases with frequency.

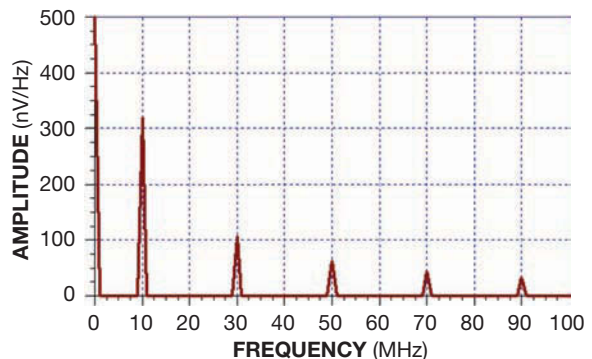

**Figure 2** The 1-nsec edge rate equates to a maximum frequency of 318 MHz. Harmonic content is significant to approximately 300 MHz.



# ARE YOU FIVE YEARS OUT?

Most people live in the present. The world of now. But a handful of us work in a unique world that doesn't quite exist yet – the world of Five Years Out.

Five Years Out is the tangible future. And the people who live and work there know that new technologies, new materials, new ideas and new electronics will make life not only different, but better. Not just cheaper, but smarter. Not just easier, but more inspired.

Five Years Out is an exciting place to be. So exciting that, once you've been there, it's hard to get excited about the present. Because we know what's coming is going to be so much better.

Five Years Out is a community of builders, designers, engineers and imaginers who navigate the path between possibility and practicality. Creating the future of everything from cars to coffeemakers.

Are you one of them?

Then you're probably working with us.

PRY FURTHER

- + Go to [www.edn.com/120315pry](http://www.edn.com/120315pry) for the references this article lists.
- + Go to [www.edn.com/pryingeyes](http://www.edn.com/pryingeyes) for more Teardowns.

# What's inside the Samsung 40W-replacement-LED light?



In February 2010, *EDN* tore down its first LED bulb (Reference 1). For \$20, you got a nondimmable bulb that produced 500 lumens at a cool white (5000K) and consumed 7W. The warm-white version of the light produced only 450 lumens. Two years later, you can buy this fully dimmable Samsung bulb for \$19.95 (list price) that puts out 550 lumens of a nice warm white (3000K), consumes 10W, and boasts a five-year warranty.



As you'd expect with a snow-cone-type bulb, the light pattern does not extend as far down as the light extension of an incandescent bulb (Reference 2).



The light uses only one LED component to produce its 550 lumens.

It's usually difficult to find out what power-management IC an LED bulb uses, and this one was no exception. By process of elimination, it seemed likely that the IC must be beneath the white blob of goo.

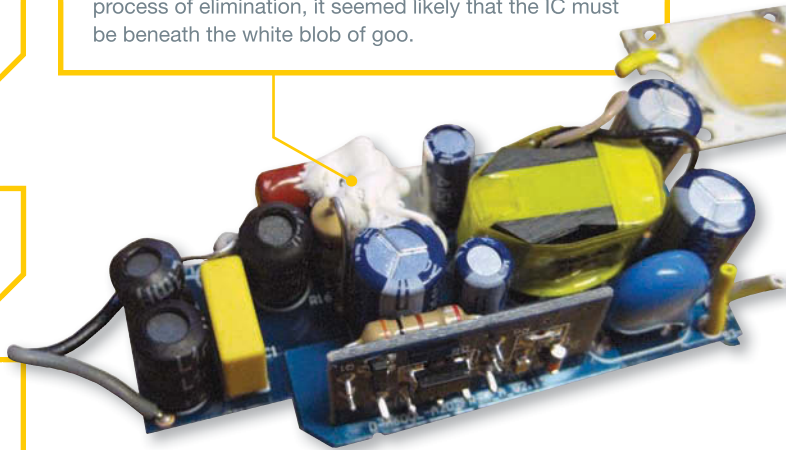

Lights that are not incandescent face a challenge when you try to control them with an old-fashioned TRIAC-based dimmer switch. The graph below shows the dimming characteristics of LED, compact-fluorescent, and incandescent bulbs, showing their dimming performance as a percentage of their highest light output, rather than an absolute measure—say, in lux. The incandescent bulb (yellow line) does not dim linearly with power. It does dim down to zero, however. A CFL (orange line) does a better job of dimming with power, and the Samsung LED light (green line) dims linearly with power. However, it drops out at slightly less than 20% of its maximum output light. I used a Taos light sensor from Adafruit, controlled by an Arduino development system, to take these measurements (Reference 3).

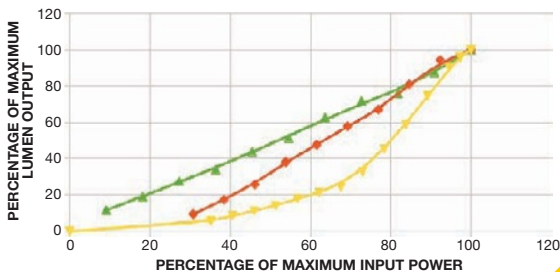

Sure enough, the vertically mounted IC shows a Power Integrations logo and a LinkSwitch part number: LNK403EG (Reference 4).

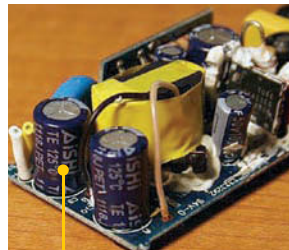

All of the electrolytic capacitors used are 125°C and most likely are properly derated, contributing to the manufacturer's five-year warranty. The bulb's packaging lists a design life of 40,000 hours.

# Parlez-vous MATLAB?

Over one million people around the world speak MATLAB. Engineers and scientists in every field from aerospace and semiconductors to biotech, financial services, and earth and ocean sciences use it to express their ideas. Do you speak MATLAB?

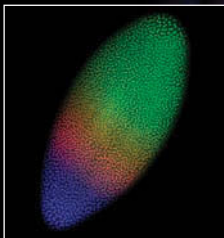

*Quantitative high-throughput gene expression imaging using data from FlyEx Database.*

*This example available at [mathworks.com/ltc](http://mathworks.com/ltc)*

**MATLAB**®  
The language of technical computing.



# MECHATRONICS IN DESIGN

FRESH IDEAS ON INTEGRATING MECHANICAL SYSTEMS, ELECTRONICS, CONTROL SYSTEMS, AND SOFTWARE IN DESIGN

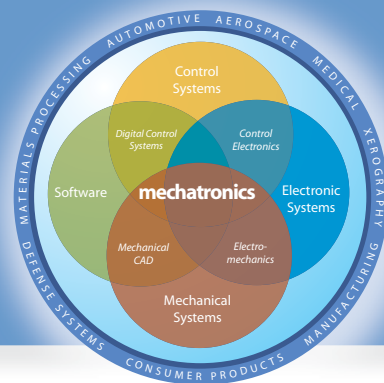

## Circuits without wires

Understanding magnetic circuits illuminates electromechanical devices.

According to novelist and physicist Charles P Snow in his influential 1959 lecture entitled “The two cultures,” not knowing the second law of thermodynamics is equivalent to having never read a work by Shakespeare. Two cultures also appear to exist in the engineering community, and the situation is worsening. At one extreme, engineers use the trial-and-error, plug-and-chug approach of just getting an answer. The other approach embraces a world of understanding through modeling and the application of the laws of nature through their language, mathematics.

The mathematical statements of Maxwell’s equations specify the divergence and curl of  $E$  (electric)- and  $B$  (magnetic)-vector fields. They include the laws of Gauss, Ampère, and Faraday. Maxwell’s four equations simply state that  $E$  diverges outward from positive charges and inward to negative charges;  $E$  curls around changing  $B$  fields;  $B$  never diverges, always looping around; and  $B$  curls around currents and changing  $E$  fields. Magnetic-circuit analysis represents algebraic approximations to exact field-theory solutions. Mechanical motion must occur in all electromechanical devices; this motion changes flux linkages. In a linear electromechanical system, inductances are functions of mechanical motion.

The figure shows in cross-section the dynamics of motion for electromechanical systems. In a cylindrical solenoid magnet, the cylindrical plunger of mass,  $M$ , moves vertically in brass guide rings of thickness,  $g$ , and mean diameter,  $d$ . The permeability of brass is the same as that of free space. A spring with a constant of  $K$  supports the plunger. Its unstretched length is  $\ell_0$ . The mechanical system that connects to the plunger applies a mechanical

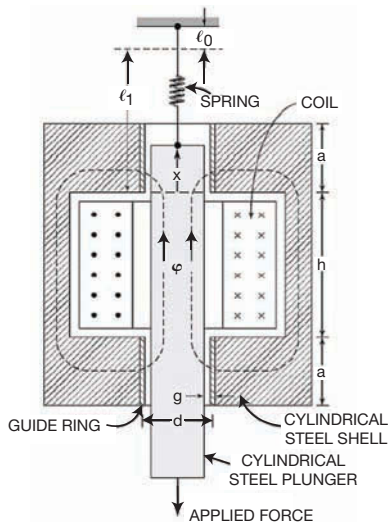

load force,  $f_l$ , to the plunger.

Assume that the frictional force is linearly proportional to the velocity and that the damping coefficient is  $B$ . The coil has  $N$  turns and exhibits resistance. Its terminal voltage is  $e_t$ , and its current is  $i$ . The effects of magnetic leakage and reluctance of the steel are negligible. The reluctance of the magnetic circuit is that of the two guide rings in series, with the flux directed radially through them. Assume constant flux density in the guide rings with respect to the radial distance because the length of the flux path in the direction of the field is much less than the diameter. The upper and lower areas of the flux path are perpendicular to the field.

For the upper gap’s reluctance expression, assume that the field is concentrated in the area between the upper end of the plunger and the lower end of the upper guide ring. As the electrical resistance of a wire,  $\ell/\sigma A$ , the reluctances of the upper and lower gaps are  $g/\mu_0\pi x d$  and  $g/\mu_0\pi a d$ , respectively, which add together to give the total reluctance. The inductance,  $L(x)$ , is equal to  $N^2$  divided by the total reluctance, and the magnetic force acting upward on the plunger is given by  $\frac{1}{2}i^2(dL/dx)$ . The induced voltage in the coil is given by  $d(Li)/dt$ . Application of Newton’s second law and Kirchhoff’s voltage law results in the following two dynamic equations of motion for the system:

$$f_t = -M \frac{d^2x}{dt^2} - B \frac{dx}{dt} - Mg - K(x - \ell_1) + 1/2L' \left[ \frac{ai^2}{(a+x)^2} \right];$$

and

$$e_t = iR + L' \left( \frac{x}{a+x} \right) \frac{di}{dt} + iL' \left[ \frac{a}{(a+x)^2} \right] \frac{dx}{dt};$$

where

$$L' = \frac{\mu_0\pi adN^2}{g}.$$

These equations provide a better understanding of the concept of circuits without wires. **EDN**



Kevin C. Craig, PhD, is the Robert C. Greenheck chairman in engineering design and a professor of mechanical engineering at the College of Engineering at Marquette University. For more mechatronic news, visit [mechatronicszone.com](http://mechatronicszone.com).



# ARE YOU READY FOR THE **X-CHIP FACTOR?**

## INTRODUCING THE **X-CHIP** USB BRIDGE FAMILY



**EX**tensive Interface Selection  
UART, FIFO, SPI, I2C, FT1248

**EX**tended Temperature Range

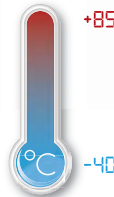

Battery Charger Dete**X**ion



**EX**pandable Clocking  
INTERNAL CLOCK GENERATION  
EXTERNAL CLOCK OUT



**EX**ceptional Support



### Additional features:

- ✓ Royalty free, validated USB driver support  
Windows, Android, Linux & Mac OS
- ✓ Low active power: 8mA
- ✓ Internal MTP memory for flexibility
- ✓ Integrated 3.3V level converter

[us.sales@ftdichip.com](mailto:us.sales@ftdichip.com)  
[www.ftdichip.com](http://www.ftdichip.com)





# TEST-DRIVEN DEVELOPMENT FOR EMBEDDED C: WHY DEBUG?

TEST-DRIVEN DEVELOPMENT HELPS YOU IMPROVE SCHEDULE PREDICTABILITY AND PRODUCT QUALITY BY ELIMINATING BUGS BEFORE THEY MAKE THE BUG LIST.

BY JAMES W GRENNING • RENAISSANCE SOFTWARE CONSULTING

**Y**ou all write code and then toil to make it work. You build it, and then you fix it. Testing is an afterthought—something you do after you write the code. You spend about half your time in the unpredictable activity of debugging. Debugging shows up on your schedule under the guise of test and integration. It is a source of risk and uncertainty. Fixing one bug might lead to another and, sometimes, to a cascade of other bugs.

IMAGE: SHUTTERSTOCK



You keep statistics to help predict how much time you need to remove the bugs. You measure and manage the bugs. You watch for the “knee” of the curve, the trend that shows that you finally are fixing more bugs than you are introducing. The knee shows that you are almost done, but you never know whether another killer bug is hiding in a dark corner of the code.

One aspect of designing for manufacturability is determining why these bugs happen to you. The simple answer is this: You put them there. When test follows development, it will find defects (Figure 1 and Reference 1). You make mistakes when you develop; the tests’ job is to find the defects. If you are any good at testing, you’ll find bugs. Following development by test means you must find, fix, and manage a boatload of defects.

This procedure, debug-later programming, is currently the most popular way to program. Write the code; debug it later. Debug-later programming is risky. You make mistakes because you are human. You can be sure of neither when the bugs will appear nor how long it will take to find them (Figure 2).

When the time to discover a bug ( $T_D$ ) increases, the time to find the bug’s root cause ( $T_{FIND}$ ) also increases—often dramatically. If it’s a few hours, days, weeks, or months from introduction to discovery, you lose context and must start the bug hunt. When you find defects outside the development phase, then you must also manage the bug. For some bugs, the time to discover a bug does not affect the time to fix the bug ( $T_{FIX}$ ), but some working code may also depend on the bug. Fixing such bugs in turn causes other bugs.

Short cycles and aggressive test automation save time and effort. You need not repeat tedious and error-prone manual tests. With test automation, the cost of retest can involve almost no additional effort. Test automation quickly detects side effects and avoids the need for debugging sessions.

In another approach, TDD (test-driven development), you develop test and production code concurrently in a tight feedback loop (references 2 and 3). In a TDD microcycle, you write a test, watch it not compile, make it compile and fail the test, make it pass, clean up any mess, and repeat the pro-

### AT A GLANCE

- ▣ Why do these bugs happen to you? You put them there.
- ▣ In TDD (test-driven development), you develop test and production code concurrently in a tight feedback loop.
- ▣ TDD might have helped to avoid the embarrassing Zune bug.
- ▣ Target-hardware bottleneck comes in various forms, and you can use TDD to avoid the bottleneck during the tight TDD-feedback loop.
- ▣ TDD helps you ensure that your code does what you think it does. How can you build a reliable system if it does not?
- ▣ TDD quickly finds small and large logic errors, preventing bugs and ultimately yielding fewer bugs.

cess until you are finished. Writing test code and writing production code are integrated processes. If you make a mistake and the new test does not pass, you immediately know about and can fix the

mistake. The tests tell you whether you get the new test to pass but introduce a bug. You plug automated tests into a unit test harness (Figure 3). Running a retest is free.

Some but not all occurrences of bugs are prevented when you perform development and test in the TDD feedback loop. TDD has a profound effect on design and how you spend your time.

In contrast to debug-later programming, the physics of TDD do not include the risk and uncertainty of tracking down bugs (Figure 4). When the time to discover a mistake approaches zero, the time to find the mistake’s root cause also approaches zero. A code problem that you recently introduced is often obvious. When it is not obvious, the developer can get back to a working system by simply undoing the last change. The time for finding and fixing the mistake is as low as it can get, given that things can get only worse as time clouds the programmer’s memory and as more code depends on the earlier mistake.

TDD provides immediate notification of mistakes that allow you to prevent many of the bugs you would otherwise have to track down. TDD

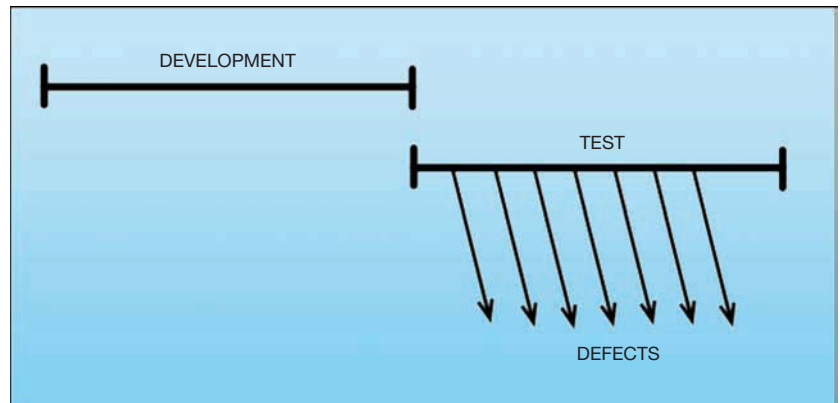

Figure 1 When test follows development, it will find defects.

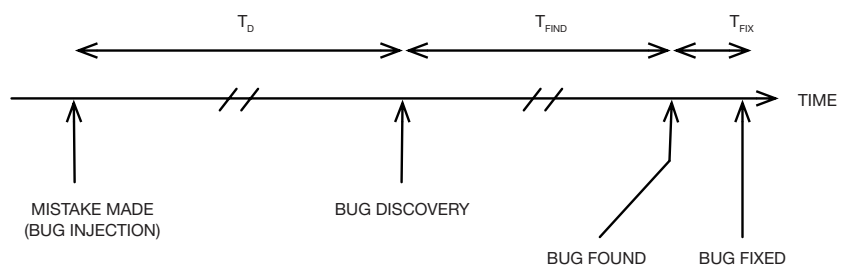
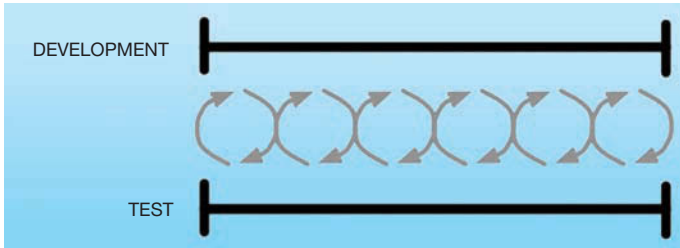
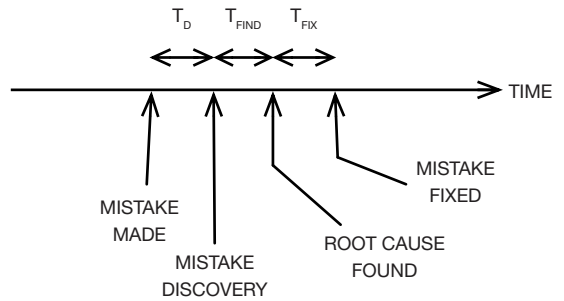

Figure 2 You make mistakes because you are human. You can be sure of neither when the bugs will appear nor how long it will take to find them.



**Figure 3** The tests tell you whether you get the new test to pass but introduce a bug. You plug automated tests into a unit test harness.



**Figure 4** TDD has a profound effect on design and how you spend your time. In contrast to debug-later programming, the physics of TDD do not include the risk and uncertainty of tracking down bugs.

represents defect prevention, whereas debug-later programming institutionalizes the wasteful activity of debugging.

### THE ZUNE BUG

TDD might have helped to avoid the embarrassing Zune bug. Microsoft's Zune competes with Apple's iPod. On Dec 31, 2008, the Zune became "brick for a day." Dec 31 was New Year's Eve and the last day of a leap year, the first leap year that the 30G Zune would experience. Many people narrowed down the Zune bug to a function in the clock driver. Although the code in **Listing 1** is not the actual driver code, it suffers from the same defect. Can you find the cure for the Zune's infinite loop in **Listing 1**?

Many code-reading pundits reviewed this code and came to the same wrong conclusion that you might. The last day of leap year is the 366th day of the year, and the Zune handled that case incorrectly. On that day, this function never returns! I wrote code to set the year and the day of the year to see whether changing the boolean code to days being equal to or greater than 366 fixes the problem, as about 90% of the Zune bug bloggers predicted. After getting this code into the test harness, I wrote the test case (**Listing 2**). Just as the Zune does, the test goes into an infinite loop. I applied the popular fix, employing reviews by thousands of programmers. Much to my surprise, the test fails; the set-year-and-time-of-day test determines the date as Jan 0, 2009. New Year's Eve parties would still have their music, but the Zune would still have a bug.

# Be As Small As You Can Be



**Optical-Die Packaging**



**System in Package**



**Multi-Chip Module**



**3D Packaging**



**Flip Chip**

**3D & Advanced Packaging**  
**Cost Effective at Any Quantity**

You don't need cell-phone production volumes to miniaturize & cost reduce your next design using the latest packaging technologies.

**Quick-Turn, On-Shore Capabilities**

Reduce your concept-to-production cycle time with our multi-discipline design teams and vertically-integrated manufacturing.

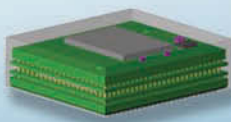

**Stacked Die**



**Chip on Board**



**Hybrid Assembly**



**Package in Package**



**Package on Package**



## Interconnect Systems, Inc.

**Designed and Manufactured in the U.S.A.**

[www.isipkg.com](http://www.isipkg.com) 805.482.2870 [info@isipkg.com](mailto:info@isipkg.com)

## LISTING 1 ZUNE CODE

```
static void SetYearAndDayOfYear(RtcTime * time)
{
    int days = time->daysSince1980;
    int year = STARTING_YEAR;
    while (days > 365)
    {
        if (IsLeapYear(year))
        {
            if (days > 366)
            {
                days -= 366;
                year += 1;
            }
        }
        else
        {
            days -= 365;
            year += 1;
        }
    }

    time->dayOfYear = days;
    time->year = year;
}
```

## LISTING 2 TEST CODE

```
TEST(RtcTime, 2008_12_31_last_day_of_leap_year)
{
    int yearStart = daysSince1980ForYear(2008);
    rtcTime = RtcTime_Create(yearStart+366);
    assertDate(2008, 12, 31, Wednesday);
}
```

That one test could have prevented the Zune bug. How would you know enough to write that one test? You would know if you could write tests for only where the bugs are. The problem is that you don't know where the bugs are; they can be anywhere. So that means

you must write tests for everything—at least everything that can break. It's mind-boggling to imagine all the tests that are necessary. Don't worry, though; you don't need a test for every day of every year. You need a test only for those days that matter.

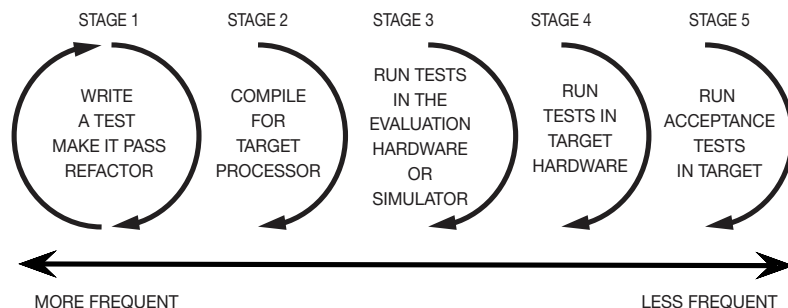

**Figure 5** The need for fast feedback leads you to move the TDD microcycle off the target to run natively on the development system. A TDD cycle contains dual-target risks and provides the benefit of a fast TDD feedback loop.

# PICO

## Surface Mount and Plug-In

## 400 / 800 Hz Transformers

Now...

up to  
150  
Watts



- 0.4 Watts to 150 Watts Power Transformers
- 115V/26V-400/800 Hz Primary
- Secondary Voltages 2.5V to 300V
- Manufactured to MIL-PRF 27 Grade 5, Class S, (Class V, 155°C available)
- Surface Mount or Plug-In
- Smallest possible size

See Pico's full Catalog immediately  
[www.picoelectronics.com](http://www.picoelectronics.com)

## PICO Electronics, Inc

143 Sparks Ave., Pelham, NY 10803

Call Toll Free 800-431-1064

E Mail: [info@picoelectronics.com](mailto:info@picoelectronics.com)

FAX: 914-738-8225



Delivery - Stock to one week

INDUSTRIAL • COTS • MILITARY



Computer programming is complex. TDD systematically gets your code working as you intend and produces the automated test cases that keep the code working.

## EMBEDDED DESIGN

When I first explored TDD, I realized that it could help with one of the problems—target-hardware bottleneck—that plague many embedded-software developers. This bottleneck comes in various forms, and you can use TDD to avoid the bottleneck during the tight TDD feedback loop. Concurrent hardware and software development is a reality for many embedded-development efforts. If software can be run only on the target hardware, you will likely suffer unnecessarily from at least one time waster. For example, the target hardware may not be ready until late in the delivery cycle, delaying software testing; it may be expensive or scarce; or it may have its own bugs. The target hardware may also have long build times or long uploading times. Most embedded-development teams experience some of these problems, which slow progress and reduce feedback for building today’s complex systems.

To avoid the target-hardware bottleneck, you can use “dual-targeting”—designing your production code and tests so that many of them run on a standard PC. Dual-targeting has its own risks, however. Testing code in the development system builds confidence in your code before committing it to the target. Most of the risks of dual-

targeting are due to differences between the development and the target environments. These differences include varying amounts of support for language features, different compiler bugs, runtime-library variations, file-name differences, and different word sizes. Because of these risks, you may find that code that runs failure-free in one environment experiences test failures in other environments.

Potential differences in execution environments should not discourage you from dual-targeting, however. On the contrary, you can work around these obstacles on the path to achieving your goals. The embedded-TDD cycle overcomes the challenges without compromising the benefits.

## DEVELOPMENT CYCLE

TDD is most effective when the build-and-test cycle takes only a handful of seconds. This approach rules out having target hardware in the loop for most programmers. The need for fast feedback leads you to move the TDD microcycle off the target to run natively on the development system. **Figure 5** shows a TDD cycle that contains the dual-target risks and provides the benefit of a fast TDD feedback loop.

By going through the stages listed in **Table 1**, you expect to find problems at the appropriate stage. For example, you would expect each stage to help find these problems. Stage 1 gives you fast feedback when you are programming, ensuring that the code does what you think it is doing. Stage 2 ensures that

your code compiles in both environments. Stage 3 ensures that the code runs the same in both the host and the target processor. The evaluation hardware may need a larger memory than the target does, so that the test and production code can fit into the address space. You can sometimes omit Stage 3 if you have a reliable target with the space to run the unit tests. Stage 4 runs the tests in the target. You could introduce some hardware-dependent unit tests in Stage 4. Stage 5 encompasses seeing whether your system works as it

**POTENTIAL DIFFERENCES IN EXECUTION ENVIRONMENTS SHOULD NOT DISCOURAGE YOU FROM DUAL-TARGETING. YOU CAN WORK AROUND THESE OBSTACLES ON THE PATH TO ACHIEVING YOUR GOALS. THE EMBEDDED-TDD CYCLE OVERCOMES THE CHALLENGES.**

should when it is fully integrated. It’s a good idea to automate at least some of Stage 5. Teams adopting TDD find significant value in Stage 1 and may not implement all of the stages.

The embedded-TDD cycle doesn’t prevent all problems, although it should help to find most problems soon after their introduction and in an appropriate stage. You should be able to manually execute stages 2 through 4 at least nightly. A continuous integration server, such as Cruise Control or Jenkins, can watch your source repository and initiate builds after check-in.

TDD helps you ensure that your code does what you think it does. How can you build a reliable system if it does not? It helps you get the code right in the first place, and it creates a regression-test suite that helps you keep your code working. You waste considerable effort in finding, chasing, and fixing bugs. Many developers are now preventing these

**TABLE 1** LIKELY PROBLEMS

Stage	Problems
1	Logic, design, modularity, interface, and boundary conditions
2	Compiler compatibility, including language features, and library compatibility, including header files and prototypes
3	Processor-execution problems, such as bugs in compiler and standard libraries, and portability problems, such as word size, alignment, and endian
4	Processor-execution problems, such as bugs in compiler and standard libraries, and portability problems, such as word size, alignment, and endian; hardware-integration problems; and misunderstood hardware specifications
5	Processor-execution problems, such as bugs in compiler and standard libraries, and portability problems, such as word size, alignment, and endian; hardware-integration problems; and misunderstood hardware and feature specifications

bugs from occurring with TDD. It fundamentally changes how you program.

TDD quickly finds small and large logic errors, preventing bugs and ultimately yielding fewer bugs. Fewer bugs in turn mean less debugging time and fewer side-effect defects. When new code violates a constraint or an assumption, the tests let you know. Well-structured tests then become a form of executable documentation.

TDD also gives you peace of mind because thoroughly tested code with a comprehensive regression-test suite gives confidence. Developers using TDD report fewer interrupted week-ends and better sleep patterns. TDD also monitors progress, keeping track of what is working and how much work is taking place. When code changes become difficult to test, it provides an early warning of design problems. **EDN**

## REFERENCES

1 Beck, Kent; and Cynthia Andres, *Extreme Programming Explained: Embrace Change*, Second Edition, Pearson Education Inc, 2005, ISBN: 0-321-27865-8.

2 Grenning, James W, *Test-Driven Development for Embedded C*, The Pragmatic Bookshelf, 2011, ISBN: 978-1-93435-662-3, <http://bit.ly/wXvDFa>.

3 Grenning, James W, "Test-Driven Development for Embedded C, Why Debug?" Embedded Systems Conference, September 2011, <http://bit.ly/wi7QEX>.

## AUTHOR'S BIOGRAPHY



James Grenning is founder of Renaissance Software Consulting, where he trains, coaches, and consults worldwide. With more than 30 years of software-development experience, both technical and managerial, Grenning brings a wealth of knowledge, skill, and creativity to software-development teams and their management. His professional roots are in embedded software, so he is leading the way to introduce Agile development practices to that challenging world. He is the author of *Test Driven Development for Embedded C* and the inventor of *Planning Poker*, an estimating technique, and participated in the creation of the *Manifesto for Agile Software Development*.

[[www.edn.com](http://www.edn.com)]

# Click Here for Low-Cost Wi-Fi® and Wi-Fi® + Bluetooth® Combination Radio Modules

<http://www.rfm.com/>



## The WLS-Series Wi-Fi and Wi-Fi + Bluetooth Combination Modules from RFM Deliver High RF Performance and Small Form Factor... and We Mean *Really Small*

### WLS1270

2.4 GHz  
802.11b/g/n

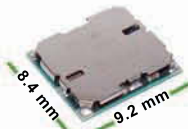

Wi-Fi Compliant Only

### WLS1271L

2.4 GHz  
802.11b/g/n

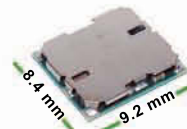

Wi-Fi and Bluetooth Compliant

### WLS1273L

2.4 GHz & 5.8 GHz  
802.11a/b/g/n

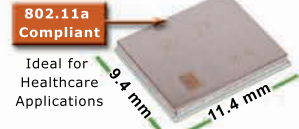

802.11a  
Compliant  
Ideal for  
Healthcare  
Applications



### Quickly Add Standards-Based Connectivity Into Products

Best-in-class WLAN and Bluetooth co-existence technology on a single-chip  
High-efficiency front-end circuits plus DC-DC converter  
Minimal external circuitry required to complete a radio design  
Software drivers are available for Linux, Android and WinCE

**NEW!**

Bluetooth v4.0  
Low Energy  
BLE



### Easily Fits Into Small Spaces: Smaller Than a Dime Yet Features High Level of Integration

Embedded ARM microprocessor  
Supports SDIO host interfaces for WLAN



### Efficiently Obtain Wi-Fi, Bluetooth, and FCC / ETSI Certification

WLAN: All three modules comply with IEEE 802.11b/g/n; WLS1273L complies with 802.11a/b/g/n  
Bluetooth: WLS1271L & WLS1273L modules comply with Bluetooth v4.0 + EDR, Power Class 1.5 + BLE  
FCC/ETSI: Like all RFM Short-Range Radios the WLS-Series modules are FCC and / or ETSI certifiable

#### WLAN Features

- IEEE 802.11 b/g/n compliant (WLS1273L 11a/b/g/n)
- Data Rates: 1-65 Mb/s
- Operating Freq Range: 2.412 to 2.485 GHz  
WLS1273L additionally operates at 4.920 to 5.825 GHz
- Output Power: up to 18 dBm

#### Bluetooth Features (WLS1271L & WLS1273L only)

- Bluetooth Version 4.0 plus EDR, Power Class 1.5
- Data Rate: up to 3 Mb/s
- Operating Freq Range: 2.4000 to 2.4835 GHz
- Output Power: up to 8 dBm
- Supply Current: 35 mA typical (DH1)

Just **how** small are we talking?

WLS1273L Module Installed on DR-WLS1273L-EV Evaluation Board

### WLS1273L Combo Module

Smaller than a Dime

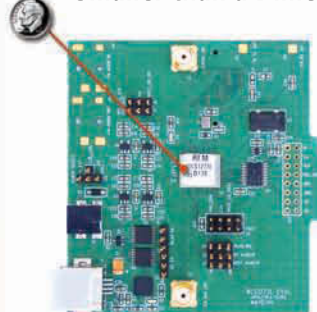

**Buy Your Evaluation Kit Today!**

Available from RFM Distributors



Avnet Memec  
Digi-Key  
Future Electronics  
Mouser Electronics

Wireless is... **RFM**  
[www.RFM.com](http://www.RFM.com)

Evaluation Kit Part Numbers

DR-WLS1270-EV DR-WLS1271L-EV DR-WLS1273L-EV

# HIDDEN INTERFACES

## A NEW PLAYGROUND FOR EMBEDDED INNOVATIONS

BY ROBERT CRAVOTTA • EMBEDDED INSIGHTS INC

**T**he rate of innovation is stagnating, say some analysts ([Reference 1](#)). The complaint is that the highly visible, and hyped, innovations fall into an incremental and predictable pattern that focuses on cost savings. Areas identified for innovation in 2012 include social media, information flow, and application stores. Another area for innovation is camera-based interfaces, such as Microsoft's Kinect, which promises users a richer way to interface with their consoles and computing devices, but the hardware's \$249 price puts this technology beyond the range of most embedded applications.

Despite these roadblocks, a number of hidden interfaces are quietly finding their way into more systems; many of these interfaces can detect a user's presence and motion. A hidden interface is one in which the system provides no prompt for the user. Thus, proximity sensing, which involves detecting that a user is within range of a sensor, is a hidden interface because, in most cases, the user knows neither that the system is performing such sensing nor why it is doing so. Motion sensing is a potential hidden interface because the motion sensing occurs, despite the presence of the user, to allow the system to adjust and adapt its behavior based on where and how it is being handled.

IMAGE SHUTTERSTOCK



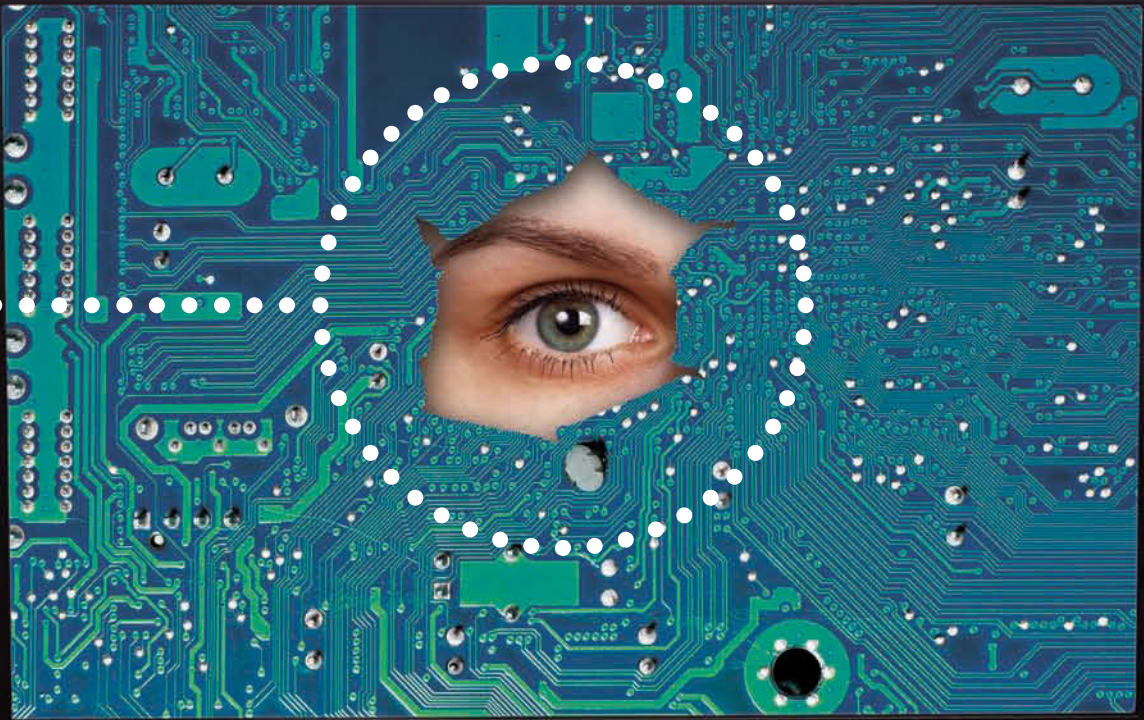

**NEW INTERFACES CAN DETECT USERS' PRESENCE AND MOTION. IN RESPONSE, DESIGNERS ARE PROVIDING NEW FEATURES TO MAKE THEIR SYSTEMS MORE RESPONSIVE TO USERS' NEEDS.**



Proximity-sensing interfaces rely on a variety of technologies. For example, automobiles that support keyless entry detect when a user is approaching the vehicle and unlock the door before the user can pull the door handle to its full open position. Additionally, on some vehicles, these systems, along with an ambient-light sensor to detect dark conditions, may turn on lights outside the vehicle to make it easier for the user to find the door handle. In addition to detecting the presence of the user, proximity sensing enables designs to explore ways to offer touchless and motion-sensing interfaces to complement pervasive touch technologies.

Motion-sensing innovations are showing up in game consoles, such as the Nintendo 3DS, and mobile devices, such as smartphones and tablets, as they take increasing advantage of built-in gyroscopes to provide new ways to pan the display. The gyroscope-based panning capability allows a user to see the contents of the display change depending on where and how he is holding the viewing device. For example, the technology allows users to explore a famous panoramic tourist site from a 360° perspective by spinning around to see what is behind them. This hidden interface allows the presentation of the

## AT A GLANCE

- ▶ Innovations in embedded designs are quietly showing up in hidden interfaces employing the detection of the presence and the motion of a user.
- ▶ Capacitive-touch sensing is evolving to include better proximity sensing with a range as long as 25 cm.
- ▶ Infrared proximity sensing provides a strong complement to other sensing technologies, such as capacitive touch, and it supports proximity sensing with a range as long as 50 cm.
- ▶ Modern gyroscopes are enabling designers to experiment with advanced motion sensing to compensate for users' movement and to present data in a richer fashion.
- ▶ Hidden-interface innovations are appropriate in myriad applications, including automotive, computing, consumer, industrial, medical, and white goods.

content to integrate with more of the user's own inertial sensing, which can provide better feedback than dragging a finger across the display to pan an image.

These emerging, hidden interfaces are becoming more practical for designers to include in designs because the cost to include them continues to drop—in

many cases, to as low as approximately a few dollars or less. The companies providing such sensing products also provide software libraries and engineering support so that embedded-system developers need neither become experts on the proper integration of these products nor work with the analog and digital components.

Available sensing approaches for proximity and motion detection include capacitive proximity detection, infrared- and ambient-light sensors, and dual-core gyroscopes.

## CAPACITIVE PROXIMITY

Capacitive sensing started to take off with the ubiquitous adoption of touch-screen interfaces in smartphones and tablets, such as the iPhone. As the sensing technology continues to mature and the production costs drop, capacitive sensing not only supports explicit touch and gestures but also, through proximity sensing, provides systems with more information about how the user is using the system. A key hidden-interface feature is the ability to detect and reject unintended touches, such as when a user's cheek touches the interface when he places the phone to his ear or when a user grips a device, thereby touching its edges.

Recently announced capacitive-sensing products, such as the Atmel QTouch AT42QT2120 and the Cypress CY8C21434, have increased the range of proximity sensing to support distances as long as 25 cm (1 foot). The companies supporting capacitive proximity sensing provide engineering support, application notes, and demonstration kits to help designers (Figure 1). The ability to reliably support capacitive proximity sensing at longer distances involves the use of algorithms that have been maturing over the past few years. These algorithms can now adjust the sensitivity gain of the sensor depending on whether it needs to perform proximity or touch sensing.

Proximity sensing enables designers to keep energy-hungry portions of the system in a deeper sleep state and wake them up just before a user makes contact. This approach can provide a better user experience because the system can react as if it were in an always-on condition without always being fully on. This type of sensing is useful for



**Figure 1** The Cypress Semiconductor CY3235 proximity-detection demonstration kit shows how to use the PSoc (programmable-system-on-chip) CapSense-enabled CY8C21434 to accurately sense the proximity of a hand or a finger along the length of a wire antenna.

# DesignNews



## CONTINUING EDUCATION CENTER

# Get current, without the hassle.

With Digi-Key's Continuing Education Center, catch up to 180 days of free, interactive courses engineered by Design News, starting January 2012. Build your engineering know how. Take one or all. It's your choice.

Tracks include: Microcontrollers Basic, Microcontrollers Advanced, MEMS Sensor Technology, Lighting, Embedded Internet and Cloud, Wireless, and Power.

**REGISTER AT**  
**[DesignNews.com/dkcec](http://DesignNews.com/dkcec)**

**FOLLOW US**

@DigiKeyCEC



Digi-Key Continuing Education Center



**UBM**  
Electronics



applications such as waking a wireless mouse and turning 3-D glasses on and off for television systems.

Capacitive proximity sensing requires the use of few or no extra components if your system also supports a capacitive-touch interface. The technology suffers, however, from the same weaknesses as capacitive touch: It works well with a user's bare fingers but less well with a user's gloved fingers when, for example, the user is employing the device outside on a cold winter day. This problem creates the opportunity to provide new or more reliable capabilities that rely on sensor fusion—that is, combining inputs from multiple sensing technologies. For this example, infrared proximity sensing nicely fits the bill.

### INFRARED PROXIMITY

Infrared- and ambient-light sensors can provide complementary sensing, including capacitive-touch sensing, to enable sensors to further adapt their operation to environmental and contextual conditions. Infrared proximity sensors commonly find use in automatic doors; lavatory toilets, soap dispensers, and paper-towel-dispensing systems; and mobile touchscreen devices. A mobile system with a display can improve the system's battery life by detecting whether the presence or lack of light affects

employing an active-sensing approach. In a passive-sensing approach, the sensor identifies changes in the ambient-light input. For example, when a person approaches an automatic door, the sensor causes a change in detected light. However, if the person then stops, the passive sensing may eventually establish a new baseline so that the system does not recognize that the person is still standing in front of the door. An active-sensing approach, in contrast, uses one or more infrared-light-emitting diodes to find reflections of known pulses of infrared light. Infrared sensing can complement capacitive-touch sensing by enabling a system to know when it should reject touches. It can also save system energy by shutting down the display when a user places a smartphone on his ear and turning the display on when the user pulls the smartphone away from his face.

The latest generation of small, low-power infrared sensors, including Silicon Labs' Si114x family of sensors (Figure 2), may also be able to drive multiple infrared LEDs to enable detection-gesture inputs in multiple dimensions. The cost to include infrared sensing currently ranges from approximately 60 cents to more than \$1 (100,000), depending on whether the system has one detector or multiple detectors.

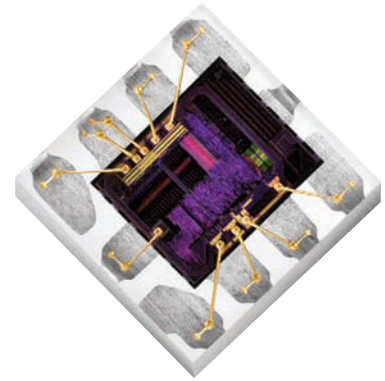

Figure 2 Silicon Laboratories' Si114x QuickSense infrared sensors pack as many as three independent LED drivers into a 2x2-mm QFN-10 package and support a sensing range as long as 50 cm, virtual slider buttons, and three-axis motion and gesture sensing.

detect coarse movements of the user's hand in multiple directions. This capability could allow users to use touchless scrolling when using a cooking application on a mobile device to advance to the next step even though their hands are covered in oils or messy food materials.

"Infrared systems will not replace existing interface technologies," says Ahsan Javed, human-interface-product manager at Silicon Labs. "Rather, they can be used to augment the current sensing systems." Such augmented devices can act with more certainty to improve the system's performance, battery life, and the user's experience with the device without requiring the user to be aware that the system is automatically adjusting many small details.

### DUAL-CORE GYROSCOPES

Gyroscopes and accelerometers are enabling new and expanded capabilities that are both visible and invisible to the end user. MEMS accelerometers and gyroscopes are replacing bulky sensors that comprise discrete components in applications such as air-bag-deployment systems for automobiles in smaller form factors and at lower costs. Since 2003, accelerometers have been used in disk drives to detect when they are falling. During the fall, the drive attempts to lock the mechanical portions of the system into a safe place to protect the drive mechanism and the stored data before the drive collides

## GYROSCOPES AND ACCELEROMETERS ARE ENABLING NEW CAPABILITIES THAT ARE BOTH VISIBLE AND INVISIBLE TO THE END USER.

the viewing conditions of the display and can automatically adjust the brightness to improve readability without any action on the user's part.

The Kindle Fire and Nook Touch demonstrate another advantage of infrared sensing over capacitive-touch sensing. Both systems use an infrared touch system because it requires no indium-tin-oxide layer over the display. This approach enables a single-layer capacitive-touch sensor to have as much as 90% transparency, improving readability and providing a noticeable quality similarity between E Ink-display output and the printed material.

Infrared proximity sensing supports the new hidden-interface capabilities

Some next-generation infrared sensors can detect a user's presence from a distance of 50 cm (approximately 2 feet). This sensing range can allow a thermostat to change what it displays based on whether the user is near or far from the unit. For example, when a user is within 50 cm of the thermostat, the display might show menu buttons along with the temperature. When the user is farther than 50 cm away, the entire display area can show a larger font of only the room temperature so that the user can read it from across the room.

By using multiple infrared LEDs and detectors, a system can support a touchless gesture interface. Depending on the sensing system's configuration, it can

with the ground or another surface.

As designers incorporate better motion-sensing technology in smartphones and tablets, the applications on these devices will begin to go beyond display rotation based on the orientation of the device. Mobile systems are increasingly able to support pedestrian-level dead reckoning to assist with indoor and multiple-floor navigation. The systems detect motion well enough to support enhanced motion-based gaming, and designers are experimenting with replacing handheld devices' ability to react to pushed buttons with the ability to instead react to motions or gestures. For example, a designer might remove the mechanical power-on/off button when the system can reliably detect when the user performs a custom motion with the device.

The three- and six-axis MEMS accelerometers and gyroscopes enabling these capabilities sell for less than \$1 and \$3 (large quantities), respectively. The recently announced MEMS L3G4IS dual-core gyroscope from STMicroelectronics sells for less than \$4 (1000). The dual-core gyroscope recognizes user motion and supports camera-image stabilization and a motion-sensing range of 65 to 2000°/sec. Sensors with a range of 65°/sec can detect small motions, such as those in optical-image-stabilization systems. The systems must sense and compensate for jitter in a user's hand to capture clear images. The ability to sense, say, 2000°/sec motion enables systems to accurately detect fast and broad motions, such as when a user performs swings at a ball during a game. As designers continue to find effective ways to use advanced motion sensing, they may be able to use nine- and 10-axis sensors, adding three axes of magnetic sensing and barometric/altitude readings. Such devices include STMicroelectronics' iNemo inertial modules.

The opportunities for hidden-interface innovations are virtually endless; nearly every application can perform better if it can adjust its behavior to a user's intended and unintended usage patterns and can mitigate and compensate for undesirable patterns without requiring users to modify their behaviors. The future looks bright for smarter appliances and products that can adjust to their users through hidden interfaces

rather than requiring the user to adapt to the appliance. **EDN**

## REFERENCE

■ Koprowski, Gene J, "2012 and the Technology Blahs," Fox News, Dec 27, 2011, <http://fxn.ws/sqNR9d>.

## AUTHOR'S BIOGRAPHY

Robert Cravotta is principal analyst and co-founder of Embedded Insights. He previously was a technical editor at EDN,

covering embedded processors, and worked in aerospace on electronics and controls for pathfinding projects, such as fully autonomous vehicles, space and aircraft power-management systems, and Space Shuttle payloads, as well as building automation systems. Cravotta received a master's degree in engineering management from California State University—Northridge and a bachelor's degree in computer-science engineering from the University of California—Los Angeles.

11:48 AM  
Why not try a different approach before you head to lunch?

1:03 PM  
Your second board is ready to test.

10:05 AM  
Your first board is ready to test.

9:00 AM  
Your circuit design is done and you're ready to make a prototype.

3:14 PM  
After a few tweaks, you're ready to make your finished board.

4:09 PM  
Your finished board is ready to go.

5:00 PM  
Nice work. You just shaved weeks off your development schedule.

# All in a day's work

**ProtoMat® Benchtop PCB Prototyping Machine**

What would your day look like tomorrow if you could cut yourself free from the board house and produce true, industrial quality PCBs right at your desk? LPKF's ProtoMat benchtop prototyping systems are helping thousands of engineers around the world take their development time from days and weeks to minutes and hours. In today's race to market, it's like having a time machine.

**“You can't beat an LPKF system for prototyping. We do up to three iterations of a design within a day.”**

Leonard Weber  
Agilent

**LPKF®**  
Laser & Electronics

[www.lpkfusa.com/pcb](http://www.lpkfusa.com/pcb)  
1-800-345-LPKF

# Oscilloscopes and ENOB

SELECTING AN OSCILLOSCOPE FOR CRITICAL MEASUREMENTS REQUIRES KNOWLEDGE OF THE QUALITY OF THE SCOPE'S MEASUREMENT SYSTEM.

When choosing an oscilloscope, banner specs, such as bandwidth, sample rate, and memory depth, provide a basis of comparison, but these specifications alone don't adequately describe oscilloscope-measurement quality. Seasoned scope users also compare a scope's update rate, intrinsic jitter, and noise floor, all of which enable better measurements. For scopes with bandwidth in the gigahertz range, another quality metric involves characterizing a scope's ADC using the effective-number-of-bits metric. When selecting which scope to use, how important is ENOB, and how effective is ENOB at predicting a scope's measurement accuracy?

Designing oscilloscope architectures for measurement accuracy involves both front-end and ADC technology blocks. A scope's front end conditions a sampled signal so that the ADC can properly digitize the signal. The front end comprises an attenuator, a preamplifier, and path routing.

Engineers who design scopes spend significant effort designing front ends that have flat frequency responses, low noise, and desired frequency roll-offs. Due to unique requirements for ADC technology, each scope vendor designs its own ADCs. Development of a new front end or a new ADC requires significant investment. Therefore, manufacturers typically use the resulting technology blocks across multiple scope families and generations. Scope-design teams maximize a scope's accuracy when these technology blocks induce the least change to the measurement of sampled signals.

Although users can characterize the combination of the ADC and the front end, they cannot easily characterize the individual technology blocks. There are many ways to determine an oscilloscope's front-end-measurement quality. Oscilloscope vendors typically use noise measurements and ENOB as useful characteristics for determining the quality of a scope's front end and ADC design. It is often beneficial to consider the entire oscilloscope performance, instead of evaluating just the ENOB or the noise floor in isolation.

Characterizing an oscilloscope's noise floor at different vertical settings and offsets provides an excellent criterion in determining a scope's measurement quality. These measurements tell the user how effective the scope's design team was in designing a quiet front end and a quiet ADC converter. Oscilloscope noise adds unwanted jitter and erodes design margins. Typically, the higher the bandwidth of the oscilloscope, the more internal noise the oscilloscope produces. The scopes accept cumulative noise from higher frequencies that are rejected by the lower frequency roll-off of lower-bandwidth scopes. A straightforward method of characterizing a scope's noise is to disconnect all inputs and measure the

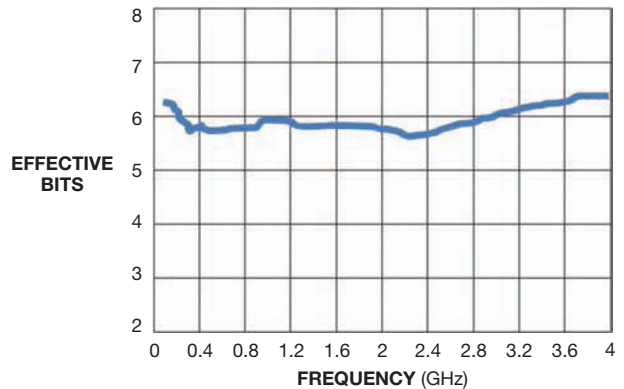

**Figure 1** In a sample ENOB plot for Agilent's Infiniium 9000A series oscilloscopes, ENOB results vary by frequency, and each scope model has a unique ENOB plot. The ENOB plot is for the entire scope system and not just the scope's 8-bit ADC.

rms-voltage readings while varying both vertical sensitivity and offset.

The IEEE has defined a method for determining the quality of ADCs using ENOB. Today's oscilloscopes typically use pipelined or flash ADC architectures. Pipelined ADCs use two or more steps of subranging to achieve a higher sample rate. For instance, Agilent's 90000A series oscilloscopes have a 20G-sample/sec ADC, which combines 80 subranges of 256M samples/sec to achieve the high sample rate (**Figure 1**).

Interestingly, and contrary to common wisdom, some scopes provide more accurate measurements when running at less than the highest sample rate, due to additional interleaving distortion that can occur at the highest sample rates and the addition of high-frequency noise. Flash ADCs have a bank of comparators that samples the input signal in parallel, each firing for its decoded voltage range. The comparator bank feeds a logic circuit that generates a code for each voltage range. Each ADC technology has inherent limitations; for example, flash ADCs are more prone to linearity errors, whereas pipelined ADCs typically have more interleaving error.

Scope vendors internally characterize stand-alone ADCs and the overall ENOB of a scope system. The resulting system ENOB is lower than the ENOB of a stand-alone ADC. Because a scope's ADC is part of an overall system, you can't use it independently. As a result, only ENOB results from the overall system are useful.

Users generally use less than the full 8 bits of a scope's ADC. For example, to take advantage of the entire 8-bit vertical range, users would have to scale waveforms to con-



sume the entire vertical range. This situation makes reading a signal more difficult, and the user runs the risk of driving the ADC into saturation, which causes undesired effects. For signals that scale to take 90% of the vertical range, the user reduces the scope's 8-bit converter to 7.2 bits ( $90\% \times 8$  bits). Front-end noise, harmonic distortion, and interleaving distortion further reduce the effectiveness of the scope's ADC.

### MEASURING ENOB

ENOB is measured as a fixed-amplitude sine wave is swept in frequency. You then capture and evaluate the resulting voltage measurements. Using time-domain methods, you calculate ENOB by subtracting the theoretical best-fit voltage versus time from what was measured. The difference between these two variables is noise, which can come from the front end of the scope from attributes such as phase nonlinearities and amplitude variations over frequency sweeps. Noise can also come from interleaving distortion from ADCs. Evaluating the same signal in the frequency domain, you calculate ENOB by subtracting the power associated with the primary tone from the entire broadband power. Both techniques provide the same result.

If you are making or analyzing ENOB measurements, remember that the spectral purity of the source you are using will affect ENOB results. First, the source and the accompanying filters should ensure that the source's ENOB is larger than the scope's ENOB. Second, ENOB values depend on the ratio of the source signal's amplitude to the scope's full-screen amplitude. ENOB values differ, for example, for sources using 75% versus 90% of the full screen. The JDEC standard uses 90% of full screen as its recommended amplitude for determining ENOB. Any comparisons of effective-bits specifications or testing must take into account both test-signal amplitudes and test-signal frequencies.

### WHAT DOES ENOB DO?

ENOB testing can measure the quality of a scope's ADC. A scope with a high ENOB has minimal timing errors; minimal frequency spurs, which interleaving distortion usually causes;

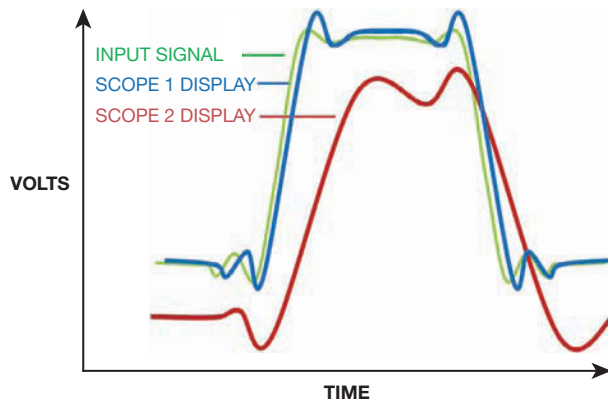

**Figure 2** Although ENOB provides one basis for scope evaluation, ENOB computations don't account for the effect of magnitude or phase flatness. Both Scope 1 and Scope 2 have the same ENOB, but Scope 2 has offset and phase-distortion errors that limit its ability to correctly display the input signal.

## Draw From Our Tool Box Of Customized Solutions

High reliability interconnect designs built for your application from prototype to production. Let us customize your solution today.

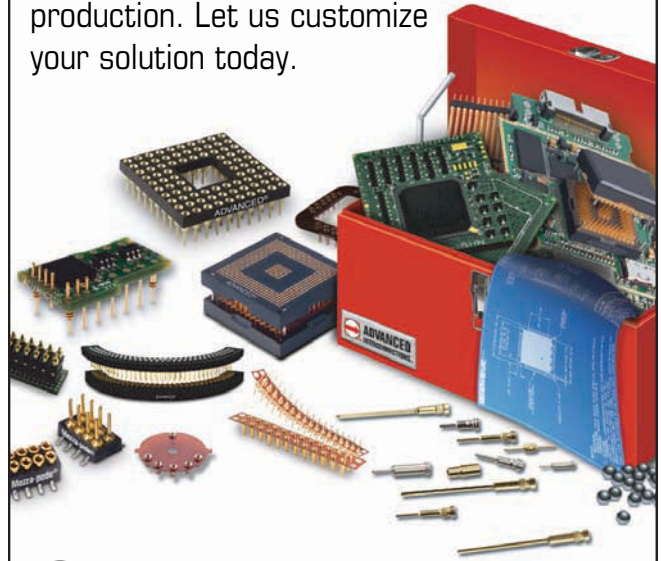

**ADVANCED**  
INTERCONNECTIONS

www.advanced.com  
401-823-5200

**NCI**

Logic Analyzers

PC-Hosted

**Digital Test, Easy and Simple**

**CAN, LIN, I2C, SPI, RS232/UART and Generic Serial Analysis included. ScopeLink for Mixed Signal Analysis.**

- 72 Channels @250MHz
- 36 Channels @500MHz
- Up to 4 Meg/Channel
- Transitional Timing
- Portable Logic Analyzer
- Online Tutorials

**GoLogic™**

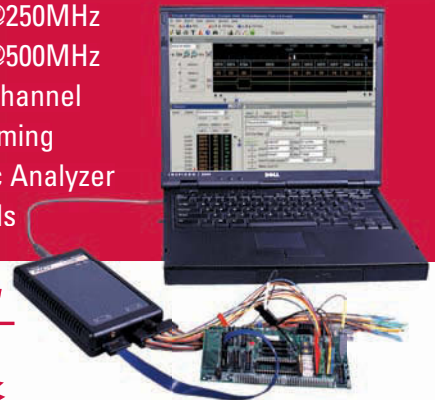

**VISIT US AT  
DESIGN WEST (ESC)  
BOOTH 1745**

www.nci-usa.com

Phone 256-837-6667 • Fax 256-837-5221  
email: contact@nci-usa.com

Want to know what is important to your peers right now?

Have an opinion you want to get off your chest?

How about a pesky design question that another engineer may be able to answer?

Stay connected and informed with **EDN on LinkedIn, Facebook, and Twitter.**



→ To join, log on to LinkedIn and type in "EDN's Electronics Design Network" under "Groups."



→ To join, go to Facebook and type in "EDN: Voice of the Engineer."



→ @EDNmagazine

Thousands of engineers and executives are already exchanging ideas with fellow *EDN* readers through LinkedIn, Facebook, and Twitter. *Join the conversation!*

**EDN**

# Microcontroller Development Tools

STREAMING TRACE  
MICROCONTROLLER EVALUATION BOARDS  
EMBEDDED DEVELOPMENT TOOLS  
TCP/IP NETWORKING SUITE  
ULINKPRO  
GUI LIBRARY  
CORTX  
FLASH FILE SYSTEM  
MIDDLEWARE LIBRARIES  
ARM COMPILER  
RTOS  
USB HOST  
CAN DRIVER  
USB DEVICE  
DEBUGGING  
ENERGY EFFICIENCY

The complete development environment for ARM® processor-based microcontroller designs.

**ARM**

1-800-348-8051  
www.arm.com/tools

**KEIL**  
Tools by ARM

AD319 | 02.12

and low broadband noise. For applications relying primarily on sine waves, ENOB provides an effective criterion for scope selection.

Although ENOB is one measurement of ADC and front-end quality, it omits several attributes. ENOB does not account for offset, phase irregularities, or frequency-response distortion. **Figure 2** shows an input signal and a display of this signal on two scopes. Both scopes have the same ENOB, but one scope displays a dramatically more accurate representation of the input signal. ENOB doesn't account for offset errors that the scope may inject. Two scopes with equal ENOB may show identical waveshapes, which differences in absolute voltage offset. Adjusting offset and measuring noise or evaluating dc-gain specifications would provide a better evaluation metric.

**A SCOPE WITH THE HIGHER ENOB ISN'T ALWAYS THE ONE WITH THE MOST ACCURATE REPRESENTATION OF THE INPUT SIGNAL.**

If all scopes had a flat phase and frequency response and identical roll-off characteristics, it would be easier to select the right scope. This isn't the case, however, and you can't usually find phase and frequency-response plots in vendors' data sheets. ENOB also doesn't account for frequency-response flatness or phase irregularities. Further, every scope model has different frequency response and phase irregularities. For example, two 6-GHz scope models produce different waveshapes when looking at a 2.1-GHz sine wave. One scope might have a slower bandwidth roll-off and minimal phase-correction algorithms, and the other might have a frequency response that peaks above 6 GHz before rolling off and a significant number of algorithms for phase correction. The scope with

[www.edn.com]

the higher ENOB isn't necessarily the scope that will show the most accurate representation of the input signal.

## INCREASING ENOB

To increase ENOB, it is a good idea to purchase an oscilloscope with higher ENOB to begin with. Scope vendors sometimes provide overall ENOB values for each scope model. Most high-end oscilloscopes come with user-selectable bandwidth-limiting filters. Turning on a filter limits the bandwidth of the oscilloscope, in turn limiting the high-frequency content, including the interleaving errors and noise, which yield a higher ENOB. Oscilloscopes can also use averaging or high-resolution mode for repetitive signals to reduce broadband noise. Using these modes can be an effective tool for greater measurement accuracy.

Whether ENOB will affect your measurement's outcome depends greatly on what you are trying to measure. You should view ENOB plots side by side with noise-floor measurements. High-speed serial data has harmonics at specific frequencies, which may pass through the measurement system with no effect from a decrease in effective bits. For these frequencies, the scope's noise floor may be a better indicator of measurement accuracy. Some signals, such as those in defense applications, are primarily fundamental sine waves. For these applications, ENOB may be an excellent criterion. Ask your scope vendor for the ENOB plot of the scope model you are considering using. It is important that you know the effective-bits performance of the instrument you choose to measure with across the full rated bandwidth of the instrument because ENOB varies with frequency. **EDN**

## ACKNOWLEDGMENT

This article originally appeared on EDN's sister site, Test & Measurement Designline, <http://bit.ly/ws4QKK>.

## AUTHORS' BIOGRAPHIES

Joel Woodward is senior product manager for oscilloscopes in the digital-test division of the Electronic Measurements Group at Agilent Technologies. During his 21 years with the company, Woodward has focused on bringing innovative system-verification and -validation products to R&D engineers

in the electronics industry. He was instrumental in the creation of three start-up businesses within Agilent and holds a patent in FPGA debugging.

Brig Asay is product manager for high-performance oscilloscopes in the digital-test division for scopes in the Electronic Measurements Group at Agilent Technologies. He manages product planning and strategic marketing for Agilent's high-performance-oscilloscope business.

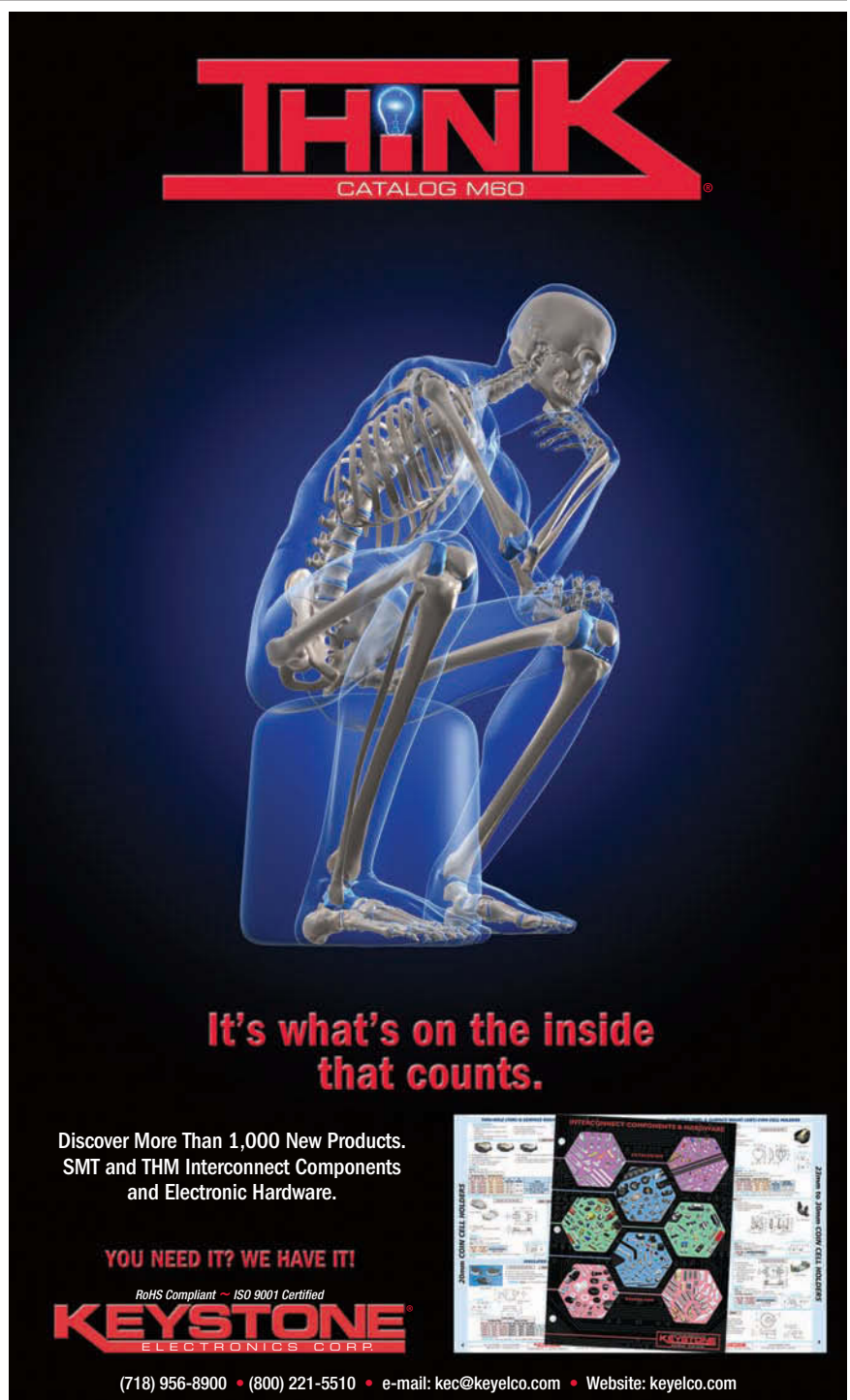

**THINK**  
CATALOG M60

**It's what's on the inside that counts.**

Discover More Than 1,000 New Products.  
SMT and THM Interconnect Components  
and Electronic Hardware.

**YOU NEED IT? WE HAVE IT!**

RoHS Compliant ~ ISO 9001 Certified  
**KEYSTONE**  
ELECTRONICS CORP.

(718) 956-8900 • (800) 221-5510 • e-mail: [kec@keyelco.com](mailto:kec@keyelco.com) • Website: [keyelco.com](http://keyelco.com)



## Condenser microphone uses dc-coupled impedance converter

Dimitri Danyuk, Miami, FL

 The diaphragm of a condenser microphone is the movable plate of a capacitor. With a polarized capacitor, the vibration of the diaphragm in relation to the back plate produces an ac audio-output voltage. The condenser capsule has a capacitance of 10 to 60 pF; thus, you should connect it to an impedance converter with extremely high input impedance for a flat frequency response.

The conventional impedance con-

verter is a JFET source follower with an additional amplifying and power-decoupling circuit. You supply power to the impedance-converter circuitry using the same microphone-cable conductors that carry the audio signal. The balanced audio pair at the XLR connector's pins 2 and 3 both carry the same positive dc voltage, or phantom power, relative to Pin 1's ground. The amplifying/decoupling circuit contains an audio transformer

### DI's Inside

43 Simple sawtooth generator operates at high frequency

46 Dual regulator handles two input voltages

► To see and comment on all of EDN's Design Ideas, visit [www.edn.com/designideas](http://www.edn.com/designideas).

or a couple of capacitors to separate the dc power from the audio signal.

High-value dc-blocking capacitors can generate measurable and audible distortion (Reference 1). Microphone

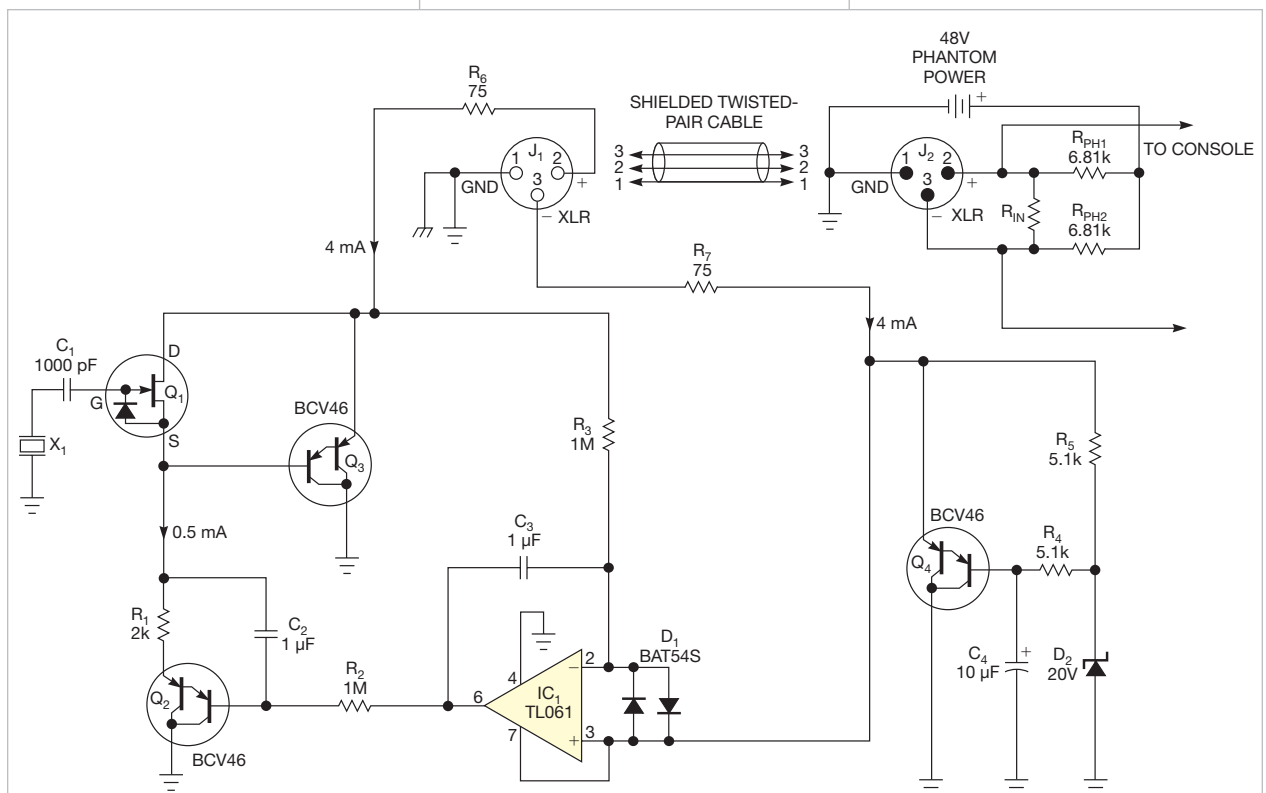

Figure 1 A feedback loop balances the dc voltage on the paired cable conductors, which power high- to low-impedance converter  $Q_1$ .

circuits rarely use the highest-quality capacitors because of space limitations. You can design the impedance converter without dc-blocking capacitors.

Figure 1 shows the self-balanced impedance converter. The self-polarized electret condenser-microphone capsule,  $X_1$ , connects to the high-impedance gate of JFET  $Q_1$ .  $Q_2$ , an ac-current source, loads source follower  $Q_1$ .  $Q_2$ , thanks to  $C_2$ , has high impedance but allows a fixed dc voltage on the  $Q_1$  source.

The circuit sources phantom power at 48V dc through  $R_{PH1}$  and  $R_{PH2}$  at the mixing-console end of the microphone cable.  $Q_2$ 's emitter drives—and  $R_{PH1}$  loads—emitter follower  $Q_3$ . The signal from  $Q_3$ 's emitter bootstraps the

**TABLE 1 PERFORMANCE PARAMETERS**

Mixing-console input impedance $R_{IN}$ (k $\Omega$ )	Peak input clipping voltage (V)	Input voltage at -80-dB (0.01%) distortion
1.2	3.1	140 mV rms
2.4	5.8	750 mV rms
10	13.6	3.1V rms

drain of  $Q_1$ , reducing the ac voltage across the gate-to-drain capacitance and resulting in lower input capacitance at the gate of  $Q_1$ .  $R_{PH2}$  supplies current for shunt-regulator-voltage sources  $D_2$  and  $Q_4$ .  $R_4$  and  $C_4$  attenuate zener-diode noise. Integrator  $IC_1$  compares the dc voltages on the XLR connector's pins 2 and 3 and, through  $Q_2$  and  $Q_3$ , maintains a difference

**TABLE 2 PERFORMANCE PARAMETERS FOR JFETs**

$Q_1$ part	A-weighted noise voltage ( $\mu$ V rms)
2SK596	4
2SK660	3.6
2SK2219	4.1
TF202C	4.6

equal to the op amp's input offset voltage. Thus, if the microphone input at the mixer console is transformer-coupled, both ends of its winding are at the same voltage. No dc will flow through the winding and saturate the core.  $IC_1$  should have a common-mode-input-voltage range equal to that of the positive-supply rail. You can accomplish this task using, for example, an op amp with a P-channel JFET input stage. Tables 1 and 2 and Figure 2 show typical performance parameters for the impedance converter in Figure 1. EDN

## REFERENCE

- 1 Gaskell, Robert-Eric, "Capacitor 'Sound' in Microphone Preamplifier DC Blocking and HPF Applications: Comparing Measurements to Listening Tests," Audio Engineering Society, Presentation 130, Paper 8350, May 2011, pg 1, <http://bit.ly/zVcgtc>.

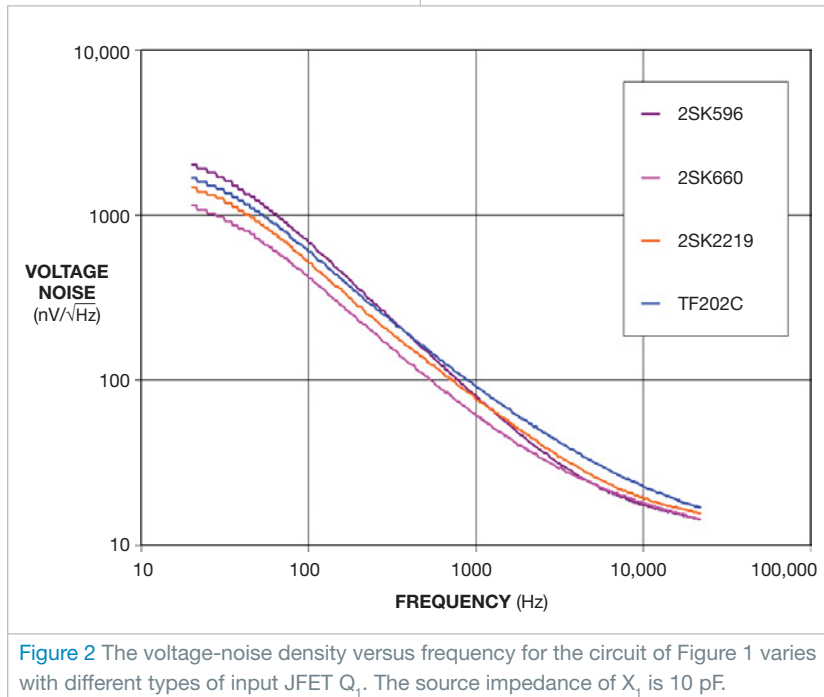

Figure 2 The voltage-noise density versus frequency for the circuit of Figure 1 varies with different types of input JFET  $Q_1$ . The source impedance of  $X_1$  is 10 pF.

## Simple sawtooth generator operates at high frequency

Luca Bruno, IIS Henseberger Monza, Lissone, Italy

Pulse-width-modulation signal-generator circuits often use an analog sawtooth-oscillator function, but it also can be useful in other applica-

tions. The inexpensive sawtooth generator in Figure 1 suits use in low-power applications operating at frequencies as high as 10 MHz and beyond and

those in which ramp linearity and frequency accuracy are not prominent concerns.

The circuit employs a single Schmitt-trigger inverter, which acts as a modified astable multivibrator. The output waveform is the voltage across timing capacitor  $C_T$ , which ramps between the lower and the upper threshold voltages of the

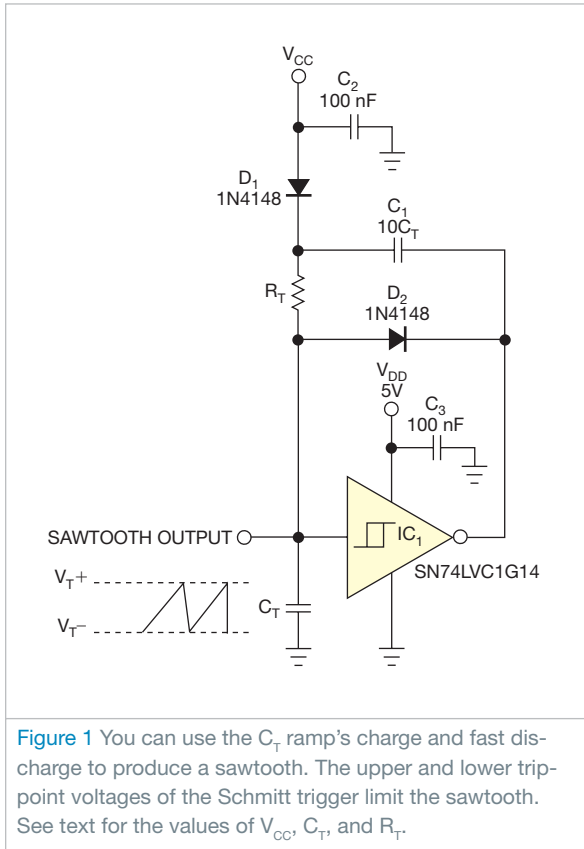

**Figure 1** You can use the  $C_T$  ramp's charge and fast discharge to produce a sawtooth. The upper and lower trip-point voltages of the Schmitt trigger limit the sawtooth. See text for the values of  $V_{CC}$ ,  $C_T$ , and  $R_T$ .

## TO IMPROVE FREQUENCY ACCURACY, USE A FAST LOGIC FAMILY WITH LOW PROPAGATION DELAY AND HIGH OUTPUT CURRENT.

inverter. Charging the  $R_T C_T$  network at constant voltage causes the ramp, so its response is exponential, approximately linear only for the initial part of the exponential rise.

A simple trick to improve ramp linearity is to charge the  $R_T C_T$  network with a higher-voltage source. Capacitor  $C_1$ , which has a value that is at least 10 times greater than that of  $C_T$ , acts as a charge pump. When the gate output is low during the falling edge of the sawtooth, capacitor  $C_1$  quickly charges through diode  $D_1$  to  $V_{CC}$  minus the for-

ward voltage of  $D_1$ . Meanwhile, capacitor  $C_T$  discharges quickly through diode  $D_2$ .

When the falling  $C_T$  voltage reaches the Schmitt trigger's lower trip point,  $V_{T-}$ , the gate output returns high. The charge on  $C_1$  drives the cathode of  $D_1$  to the sum of the voltage of capacitor  $C_1$  and the gate's high output voltage.  $D_1$  becomes reverse-biased, and the  $R_T C_T$  network begins to charge to the voltage on  $C_1$ , along with the gate's high output voltage. When  $C_T$  reaches the Schmitt trigger's upper trip point,  $V_{T+}$ , the gate's output returns low, and the cycle repeats.

Ramp linearity is proportional to the sum of the  $V_{CC}$  and  $V_{DD}$  supply voltages. Because  $V_{DD}$  is fixed at 5V, you can improve ramp linearity if  $V_{CC}$  can assume a value higher than that of the inverter. You can estimate the ramp's nonlinearity error using the following equation:

$$E_{NL}\% = \left( \frac{M_I - M_F}{M_I} \right) 100,$$

where  $E_{NL}\%$  is the percentage of nonlinearity error,  $M_I$  is the initial slope of the ramp, and  $M_F$  is the final slope of the ramp, and

$$E_{NL}\% = \left( \frac{V_{T+} - V_{T-}}{V_{CC} + V_{DD} - V_F - V_{T-}} \right) 100,$$

where  $V_F$  is the forward-voltage drop across  $D_1$ .

The  $R_T C_T$  time constant sets the frequency,  $F_O$ , of the sawtooth signal. You can estimate the frequency by applying a simple model to the circuit, which neglects the discharge time of  $C_T$  and any discharge of  $C_1$ , yielding

the following equation:

$$F_O = \frac{1}{K R_T C_T},$$

where  $K$  is a constant, which the following equation defines:

$$K = \ln \left( \frac{V_{CC} + V_{DD} - V_F - V_{T-}}{V_{CC} + V_{DD} - V_F - V_{T+}} \right).$$

By simulating the circuit with  $C_T = 100$  pF and  $R_T = 2.2$  k $\Omega$ , which agree with the values that the equations theoretically calculated, you can obtain ramp-nonlinearity errors of 28% with both  $V_{CC}$  and  $V_{DD}$  equal to 5V, 18% with  $V_{CC}$  of 10V and  $V_{DD}$  of 5V, and 14% with  $V_{CC}$  of 15V and  $V_{DD}$  of 5V.

The breadboarded circuit has  $V_{DD} = V_{CC} = 5V$ ,  $C_T = 100$  pF, and  $R_T = 2.2$  k $\Omega$ .  $IC_1$  is a standard dual-in-line, eight-pin 74HC14, which has a maximum propagation delay of 15 nsec versus 4.4 nsec for the SN74LVC1G14 inverter with a  $V_{DD}$  of 5V. The frequency is approximately 12.7 MHz.

$C_T$  should be a low-leakage film capacitor, and its value should be kept low to reduce its charging and discharging of a large amount of energy. Select  $C_T$  with a large enough value compared with the gate's input capacitance and unwanted stray capacitances so that they do not introduce a significant error. Select  $R_T$  with a small enough value that the load impedance, gate input, and stray capacitances do not introduce significant error. You can use any CMOS Schmitt-trigger inverter to test the circuit. To improve frequency accuracy, however, you should use a fast logic family with low propagation delay and high output current, such as the single-gate SN74LVC1G14 from Texas Instruments.

You should measure the threshold trigger voltages, especially  $V_{T-}$ , directly from the circuit under test before using the preceding equations. Quickly discharging  $C_T$  to ground through a finite-propagation-delay inverter causes the lower limit of the ramp to reset below the lower threshold,  $V_{T-}$ . You can compensate for the resulting error if you use the measured value of  $V_{T-}$ , which takes this effect into account. **EDN**



# Navigate to the Future

*Maxim speeds you past integration challenges on the road ahead*



**More multimedia. More sensors. More fuel efficiency.** In 2012, the key word is "more." But cars aren't getting any bigger. And your job isn't getting any easier. At Maxim, we're used to tackling even the most daunting integration challenges. So whether you need more performance on board—or more functions in a chip—we can help you get there faster.

## Featured Technologies

- GMSL SerDes chipset with coax drive halves cabling costs for in-vehicle networks, so you can add new multimedia and safety systems at a much lower price point
- Battery-monitoring ICs feature a patented SMBus daisy-chain interface to improve safety, performance, and reliability in hybrid and electric vehicles
- Multi-output PMICs supply all the power rails you need to integrate functions like voice control, MP3 playback, and USB connectivity into infotainment systems
- Fully integrated RF tuners deliver new levels of performance for active antennas, mobile TV, HD radio, and universal GPS

Learn about these and other automotive solutions.

[www.maxim-ic.com/Auto-Ad](http://www.maxim-ic.com/Auto-Ad)

**MAXIM**  
INNOVATION DELIVERED®

**MAXIM**  
DIRECT

[www.maxim-ic.com/shop](http://www.maxim-ic.com/shop)

**AVNET**  
electronics marketing

[www.em.avnet.com/maxim](http://www.em.avnet.com/maxim)

**Digi-Key**  
electronics

[www.digikey.com/maxim](http://www.digikey.com/maxim)

**MOUSER**  
ELECTRONICS

[www.mouser.com/maximic](http://www.mouser.com/maximic)

Originally published in the January 21, 1993, issue of EDN

## Dual regulator handles two input voltages

David L Dinsmore, Linear Technology Corp, Dallas, TX

The circuit in Fig 1 supplies both 3.3 and 5V to transitional circuits that employ both the new 3.3V and older 5V devices. Additionally, because the regulator accepts either 3.3 or 5V inputs, you could plug it into either a new 3.3V system or an old 5V system.

The circuit consists of two sections: a dc/dc converter and a double-pole, double-throw (dpdt) switch. The dpdt switch comprises a pair of dual n-channel MOSFETs ( $Q_2$  and  $Q_3$ ) and their associated high-side drivers.

Upon power-up, the comparator in  $IC_2$  determines the state of the circuit. The comparator's output,  $IC_2$  pin 6, goes to the input of the MOSFET driver,  $IC_1$ . The driver internally generates a gate-drive voltage 8.8V above the device's

supply voltage. This high voltage drives the appropriate MOSFETs in  $Q_2$  and  $Q_3$ .

$IC_2$  is also the heart of a flying-capacitor, buck/boost dc/dc converter. Unlike other switching-regulator schemes, this topology needs no transformers. Transistor  $Q_1$  controls this section's output voltage,  $V_S$ . When  $V_{IN}$  is at 5V,  $Q_1$  is off, forcing the section to operate as a step-down converter. In this mode, the section produces 3.3V, which goes to the output through  $Q_{3B}$ . Also in this mode, 5V power goes directly through  $Q_{2A}$ , and  $Q_{2B}$  and  $Q_{3A}$  are both off.

When  $V_{IN}$  is 3.3V,  $IC_1$  turns on  $Q_1$ , shorting out the 140-k $\Omega$  resistor and forcing the dc/dc-converter section into step-up mode. In this mode the converter section generates 5V at  $V_S$ , powering the 5V

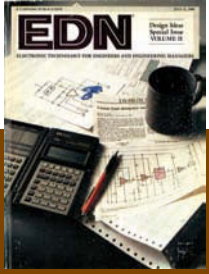

**WANT TO SEE MORE OF THE CLASSICS?**

Revisit 50 of the best Design Ideas from the Golden Age of electrical engineering.

<http://bit.ly/DesignIdeasClassics>

output via  $Q_{2B}$ . Also in this mode, 3.3V goes directly from the circuit's input to the output via  $Q_{3A}$ .  $Q_{2A}$  and  $Q_{3B}$  are both off.

No-load quiescent current consumption is approximately 500  $\mu$ A. Lower-frequency converters would reduce power consumption at the expense of a larger inductor. The efficiency of the dc/dc-converter section is 73% in either mode. But because this power accounts for only half of the circuit's output power, the circuit's overall efficiency is approximately 80% with  $V_{IN}=3.3$ V and 86% with  $V_{IN}=5$ V. **EDN**

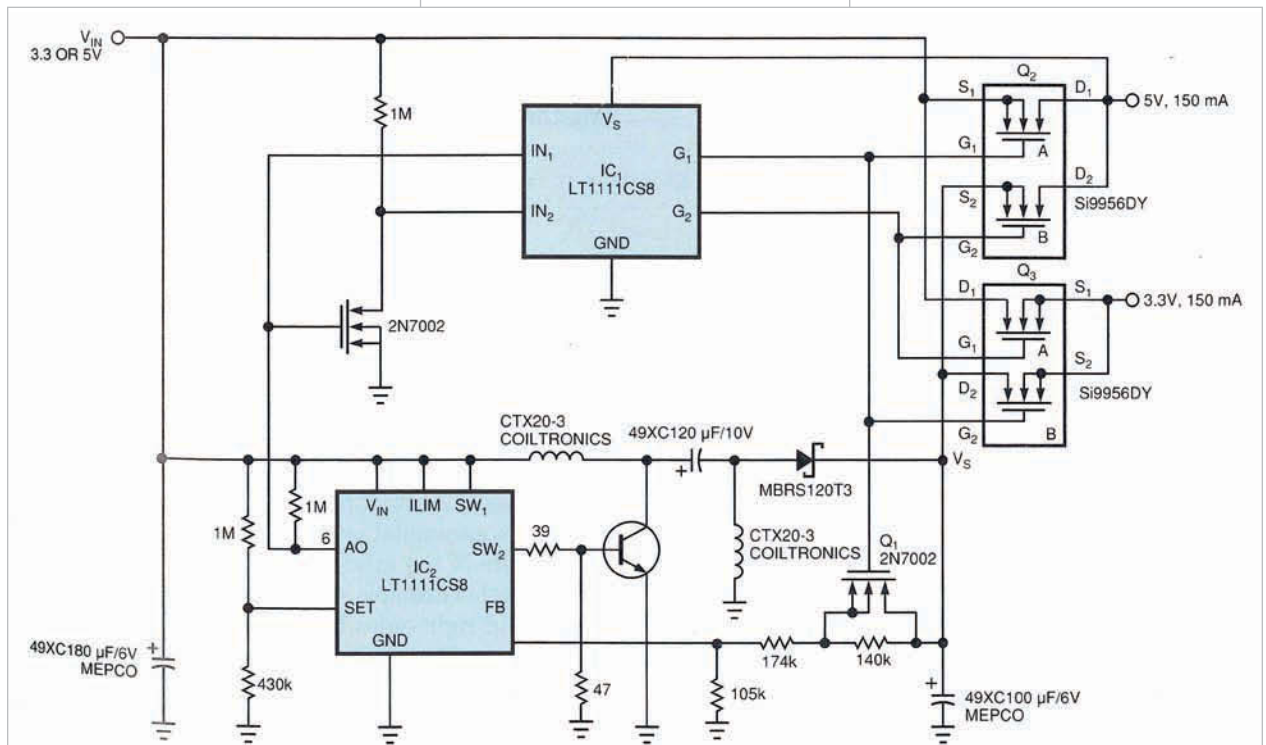

**Figure 1** During the transition from 5V components to 3.3V components, dual-output regulators such as this one will let engineers design surface-mount pc boards bearing both 3.3 and 5V devices. Further, this novel regulator will accept either 3.3 or 5V input power.

# ACE AWARDS

EE Times  
EDN

Tuesday, March 27, 2012  
6:30-8:30 pm  
Fairmont San Jose

## Finalists Announced!

EE Times and EDN Proudly Present

### 2012 UBM Electronics ACE Awards

Two Powerhouse Award Programs – Better Together!

EE Times' ACE Awards and EDN's Innovation Awards have joined forces to honor the people and companies – the creators – behind the technologies and products that are changing the world of electronics and shaping the way we work, love and play.

#### 2012 UBM Electronics ACE Award Finalists

##### STARTUP OF THE YEAR

- SuVolta, Inc.
- Calxeda
- LineStream Technologies
- mCube
- ArrayPower

##### COMPANY OF THE YEAR

- Cadence Design Systems, Inc.
- NXP Semiconductors
- Xilinx, Inc.
- Maxim Integrated Products, Inc.
- Qualcomm, Inc.

##### EXECUTIVE OF THE YEAR

- Freescale Semiconductor
- Renesas Electronics Corporation
- ARM
- Cadence Design Systems, Inc.
- JUKI

##### DESIGN TEAM OF THE YEAR

- SuVolta, Inc.
- Kontron
- Tiler Corporation
- Philips Lumileds
- Intel and Micron IMFT Joint Development Project

##### ULTIMATE PRODUCTS

###### SoCs

- Saankhya Labs Pvt Ltd
- Cadence Design Systems
- calxeda
- STMicroelectronics
- Xilinx

###### Analog ICs

- NXP Semiconductors
- Integrated Device Technology
- SiTime Corporation
- TriQuint Semiconductor, Inc.
- Microchip Technology Inc.

###### MCUs, FPGAs, Microprocessors

- NXP Semiconductors
- Freescale Semiconductor
- STMicroelectronics
- ARM
- Xilinx

###### Power

- Texas Instruments
- STMicroelectronics
- SynQor
- Analog Devices
- Linear Technology

###### Human-Machine Interface Technology

- austriamicrosystems
- Freescale Semiconductor
- Integrated Device Technology
- Movea
- Cypress Semiconductor

###### Software

- Zuken
- Cadence Design Systems
- Synopsys
- Microchip Technology Inc.
- NXP Semiconductors N.V.

###### Passive Components, Sensors, Indicators and Interconnects

- NXP Semiconductors N.V.
- Texas Instruments
- Analog Devices Inc.
- Plessey Semiconductors
- Aptina Imaging Corporation

###### Development Kits, Reference Designs & SBCs

- Mistral Solutions Pvt. Ltd.
- Xilinx
- Kontron
- Nordic Semiconductor
- Freescale Semiconductor

###### Test & Measurement Systems & Boards

- LeCroy Corporation
- Oscium
- Tektronix
- National Instruments
- Azimuth Systems

##### INNOVATOR OF THE YEAR

- Integrated Device Technology
- Philips Lumileds
- CSR
- Monolithic 3D Inc.
- Arteris

##### ENERGY TECHNOLOGY AWARD

- SolarBridge Technologies
- Echelon Corporation
- Cogenra Solar
- Freescale Semiconductor
- Maxim Integrated Products

Winners will be announced as the UBM ACE Awards on March 27. Purchase tickets now [www.ubm-ace.com](http://www.ubm-ace.com)

SPONSORS:

EXECUTIVE PLATINUM



PLATINUM



SILVER



ASSOCIATE





# supplychain

LINKING DESIGN AND RESOURCES

## Clamping down on counterfeits

President Barack Obama late last year signed electronics anticounterfeiting provisions into the 2012 NDAA (National Defense Authorization Act). These provisions could reverberate across the electronics supply chain—from defense contractors to commercial OEMs and component suppliers. “Companies are still assessing what [these provisions] mean, but the scope and scale of application is extremely broad,” says Trey Hodgkins, senior vice president for national security and procurement policy at TechAmerica.

Reports of counterfeits have quadrupled in recent years, rising from 324 in 2009 to 1363 in 2011, according to consulting company IHS. IHS drew

gate the growing problem,” says Rory King, director of supply-chain-product marketing at IHS.

The anticounterfeiting measure directs the Secretary of Defense to “implement a program to enhance contractor detection and avoidance of counterfeit electronic parts.” The law makes defense contractors responsible not only for detecting and avoiding the use of counterfeit parts but also for the cost of any required rework if it is discovered that their products have used counterfeit parts. Previously, companies negotiated such mitigation costs on a case-by-case basis, says Hodgkins.

Elements of the Department of Defense program, details of which are due later this year, are to include inspection and



when the Senate Armed Services Committee held hearings on the topic. But the hearings focused on defense contractors and specialty distributors rather than commercial-component makers, resellers, or OEMs, says Hodgkins. The commercial segment is only now “awakening to the fact that, if [it is] going to sell its product to someone who might use it in a DOD end item ... even if it's a commodity [purchase], then [the commercial vendor] would have to ... assume liability,” he adds.

When a part fails in a commercial system, manufacturers rely on the warranty model. They simply replace the defective part. “I suspect [that] the counterfeit issue is just as prevalent in the consumer-electronics world; it's just that nobody reports [those parts failures],” says King. The new law opens the possibility that such parts failures would require a major investigation by the manufacturer, says Hodgkins. For example, if a failure in a DOD-owned Dell laptop were due to a faulty, possibly counterfeit part, Dell might have to

determine whether the component was counterfeit and what other products used the part.

The law will affect the gray market, as well. The military relies on the open market to source replacements for obsolete parts that the original manufacturer no longer makes. An investigation by the Senate Armed Services Committee documents how counterfeits can make their way through the open market and into military systems. In China, for example, manufacturers harvest commercial electronic components from PCBs in e-waste, remove their markings, and replace those markings with fake markings. They then resell them—sometimes as military-grade parts—into the open market.

The new law requires the government to buy parts either directly from the manufacturer, the manufacturer's authorized distributors, or trusted suppliers. To be trusted suppliers, vendors would have to meet certain criteria and would be held liable if they sell a counterfeit part to the government.

The DOD is investigating new ways of detecting counterfeits, including a technology from Applied DNA Sciences that uses plant DNA to authenticate goods. According to the Defense Logistics Agency, which runs a pilot program, an Altera production plant has manufactured and marked chips with botanical DNA and then moved them to an independent distributor without interrupting the supply-chain process. For more, go to <http://bit.ly/x9PYpk>.

—by Tam Harbert

## A new technology uses plant DNA to authenticate goods in a range of industries.

the data from ERAI Inc, an information-services company that reports on the global electronics supply chain, and the GIDEP (Government-Industry Data Exchange Program), which shares information on the life cycles of systems and equipment. US-based military- and aerospace-electronics companies reported most of the counterfeiting incidents. However, the parts themselves could affect electronics products worldwide. “Most companies lack the awareness and the capability to effectively detect and miti-

testing of electronic parts, processes to abolish counterfeit-part proliferation, mechanisms to enable traceability of parts, methods of identifying counterfeit parts, and “the flow down of counterfeit avoidance and detection requirements to subcontractors,” according to the law. That last provision, in which liability will pass back through the electronics supply chain, is one of TechAmerica's main concerns. The growing problem of counterfeit parts in the military and aerospace industry came to the forefront in November,

# Accelerating Your Success.™



*Embedded Solutions*

## Three Times the **Power**

**People. Products. Services.** The powerful combination of Avnet and Bell Microproducts provides the expertise you need to accelerate your success. Our combined team gives you access to world-class resources. Bringing industry leading line cards together, we now deliver the most extensive inventory of brand name systems, embedded hardware, displays, storage and software. And, with our enhanced services you have access to Avnet's leading ISO integration centers, financial solutions and supply chain strategies.



1 800 332 8638

[www.avnetexpress.com](http://www.avnetexpress.com)

Follow us on Twitter!  
[www.twitter.com/avnetdesignwire](http://www.twitter.com/avnetdesignwire)





# designwest

center of the engineering universe

## Everything you need to know in one location at one time.

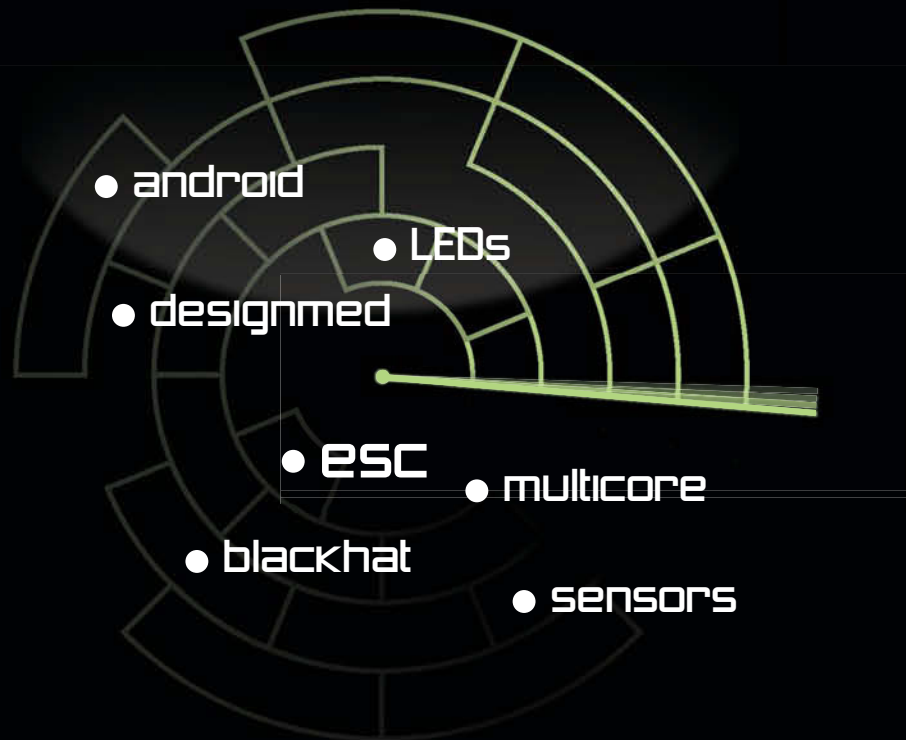

It's incoming fast! For the first time, seven summits including ESC converge at DESIGN West, creating a burst of expert training and education, hands-on knowledge exchanges, and the latest products and techniques. Be here, at the center of the engineering universe.

→ March 26-29, 2012 ←

McEnery Convention Center  
San Jose, CA

[ubmdesign.com](http://ubmdesign.com)



Register  
Now

Sharpen the skills you need now.  
Embedded HW and SW design ■ Total systems integration  
Power management ■ Open source software ■ Android  
Embedded security ■ LEDs and sensors ■ And more key topics



# productroundup

## AMPLIFIERS AND OSCILLATORS



### STMicro TDA7498E Class D audio amp touts 3.2W/mm<sup>2</sup> power density

↘ The TDA7498E Class D audio amplifier offers flexible audio-system configuration in both stereophonic and monophonic modes and includes a monophonic parallel feature for driving subwoofer/woofer channels in 2.1-channel setups. The device has a 100-dB SNR and provides selectable, fixed-gain settings of 23.8, 29.8, 33.3, and 35.8 dB. The device has 160W total output power on each channel in an area of 100 mm<sup>2</sup>. It also features pop/click noise suppression, standby and mute, and balanced input for TDMA noise rejection. Smart current protection recognizes when the speaker requires a peak of current for a specific frequency range and automatically prevents any interruptions in the sound flow. Price is \$6 (1000).

STMicroelectronics, [www.st.com](http://www.st.com)

### Intersil 40V ISL28407, 408, and 417 provide low bias-current drift

↘ The 40V ISL28407, ISL28408, and ISL28417 quad precision amplifiers feature bias-current drift 30% lower than competitive products, according to the vendor. The ISL28407 operates from 4.5 to 40V with a bias-current drift of 0.3 pA/°C over -40 to +85°C. Maximum offset voltage is 90 μV, and offset drift is 0.8 μV/°C. Maximum power is 290 μA per channel, bandwidth is 1 MHz, and noise is 13 nV/√Hz at 1 kHz. The ISL28408 features 250 μA maximum power per channel. It supports input signals as low as 0.5V below the negative supply rail. Noise is 15.8 nV/√Hz at 1 kHz. The device operates from one 3 to 40V supply or a dual ±1.5 to ±20V supply. The ISL28417, targeting use in front ends, DAC buffering, precision voltage regulation, and low-noise instrumentation, consumes 530 μA maximum per channel, with noise of 250 nV p-p and 8 nV/√Hz at 1 kHz. Maximum offset voltage is 70 μV, and offset drift is 0.75 μV/°C. The devices feature more than 4-kV ESD-input protection and an operating temperature range of -40 to



## The World's smallest Real Time Clock Module RV-4162-C7

Size: 3.2 x 1.5 x 0.8mm, Accuracy: +/-20ppm @ 25°C

Operating Temp. Range: -40 to +85°C, I<sup>2</sup>C Interface



Micro Crystal AG  
Muehlestrasse 14 CH-2540 Grenchen Switzerland  
Phones International +41 32 655 82 82 US: +1 847 818 98 25  
sales@microcrystal.com www.microcrystal.com



A COMPANY OF THE **SWATCH GROUP**

# productroundup

+125°C. They come in 14-lead SOIC packages and 14-lead TSSOPs. Prices for the ISL28407, ISL28408, and ISL28417 start at \$2.75, \$2.95, and \$2.70 (1000), respectively.

Intersil Corp, [www.intersil.com](http://www.intersil.com)

## Microchip MCP6N11 amplifier offers on-chip calibration

▶ The MCP6N11 instrumentation amplifier features the vendor's mCal technology, an on-chip calibration circuit that enables low initial offset voltage and a means of controlling offset drift. The device has a gain-bandwidth product of 500 kHz and features a hardware-shutdown

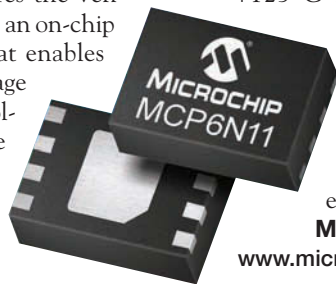

pin. Its 1.8V operation allows two 1.5V batteries to be drained beyond typical use. The device targets use in the consumer, industrial, and medical markets, such as in signal and sensor conditioning and instrumentation. Two user-supplied external resistors set gain of 1, 2, 5, 10, or 100V/V. At a gain of 100, CMRR is typically 100 dB and can be as high as 115 dB, and PSRR is 112 dB at a gain of 100. Supply current is typically 800  $\mu$ A, and the device operates from a 1.8 to 5.5V supply. It operates over a -40 to +125°C range. The MCP6N11

comes in an eight-pin SOIC package and an eight-pin, 2x3-mm TDFN package and sells for \$1 (10,000). A Wheatstone-bridge reference design sells for \$34.99.

Microchip Technology,

[www.microchip.com](http://www.microchip.com)

## FOX922-GP oscillators target GPS applications

▶ The FOX922-GP series of oscillators is available in six supply voltages from 1.8 to 3.3V. The ROHS-compliant SMD oscillators offer stability as high as  $\pm 0.5$  ppm across an operating temperature range of -30 to +85°C and have gold termination finishes for portable systems requiring precision timing. Standard frequencies for the TCXO oscillators range from 16.367667 to 38.4 MHz, with 10 varieties available. Minimum peak-to-peak voltage is 0.8V, phase noise at 16.369 MHz with 10-kHz offset is typically -147 dBc/Hz, and output load is (10 k $\Omega$ /10 pF) $\pm 10\%$ . Frequency stability over the supply-voltage change and



# XpressO<sup>TM</sup> Oscillators...

**They've Changed Everything!**

- Lower cost than you're paying now (much lower...call for a quote!)
- Faster delivery (samples shipped from Fox the next day; production quantities in days, not weeks!)
- 1 picosecond phase jitter (10X better than programmables!)
- Choice of 2.5 V or 3.3 V supply voltages
- Custom frequencies from 0.75MHz to 1.350GHz (the exact frequency you need, without a premium and without delay)
- 7 x 5 mm, 5 x 3.2 mm and 3.2 x 2.5 mm package sizes
- Choice of XOs and VCXOs
- Internal serial ID with comprehensive traceability
- And a lot more!!!

Like we said...XpressO changes everything. Details await you on our web site! Once again...Fox Rocks!

**Over 20 Million Shipped!**

**FOX Electronics**  
We're On Your Frequency.  
888-GET-2-FOX (888.438.2369)  
Outside the US: +1.239.693.0099  
e-mail: [foxonline.com/email.htm](mailto:foxonline.com/email.htm)

▶ [www.foxonline.com](http://www.foxonline.com)



over the load change is  $\pm 0.2$  ppm. Moisture-sensitivity level is one, and storage temperature range is  $-40$  to  $+85^\circ\text{C}$ . Reflow-soldering temperature is  $260^\circ\text{C}/10$  sec. The 16.368-MHz 922-GP oscillator sells for \$1.21 (15,000).

**Fox Electronics**, [www.foxonline.com](http://www.foxonline.com)

## Diodes Inc offers replacements for 555 timer ICs

 The NE555, SA555, and NA555 555 timer ICs are drop-in replacements for the industry-standard parts. The devices support a range of



operating temperatures to cover the commercial and industrial requirements, operating at 0 to 70,  $-40$  to  $+85$ , and  $-40$  to  $+105^\circ\text{C}$ , respectively. The devices feature a maximum supply voltage of 18V, an input voltage of 18V, and an output current of  $\pm 225$  mA. Package thermal-resistance junction-to-ambient and junction-to-case temperatures are 130 and  $15^\circ\text{C}/\text{W}$ , respectively. The devices sell for 7.5 cents (50,000).

**Diodes Inc**, [www.diodes.com](http://www.diodes.com)

## TI INA149 differential amplifier features 100-dB CMRR

 The INA149 differential amp has a minimum CMRR of more than 90 dB throughout the industrial temperature range of  $-40$  to  $+125^\circ\text{C}$ . Extended input-common-mode voltage of  $-275$  to  $+275\text{V}$  ensures accurate monitoring of signals in high-common-mode voltages, eliminating the



need for multiple supply sources and analog-isolation components to interface to an ADC. Signal bandwidth is 500 kHz, and maximum initial gain error is 0.02%. According to the vendor, the INA149 has twice the slew rate and full-power bandwidth of its closest competitor for applications that require the monitoring and quick correction of abrupt changes, such as short-circuit conditions. The device comes in a  $4.9 \times 6$ -mm SOIC package and sells for \$2.70 (1000). The \$49 INA149EVM evaluation module is also available.

**Texas Instruments**, [www.ti.com](http://www.ti.com)

## EDN ADVERTISER INDEX

Company	Page
Advanced Interconnections	39
Agilent Technologies	19, C-3
Analog Devices	15
ARM Inc	40
Arrow Americas Components	21
Avnet	49
Coilcraft	4
Digi-Key Corp	C-1, C-2
FDTI Chip	25
Fox Electronics	52
Hapro Inc	53
Interconnect Systems Inc	28
International Rectifier	7
Keystone Electronics	41
Linear Technology	C-4
LPKF	37
MathWorks	23
Maxim Integrated Products	45
Micro Crystal AG	51
Mouser Electronics	6, 8
National Instruments	13
NCI	39
Pico Electronics Inc	11, 29
RF Monolithics Inc	17, 31
Silicon Labs Inc	3
UBM EDN	35, 40, 47, 50

EDN provides this index as an additional service. The publisher assumes no liability for errors or omissions.

[[www.edn.com](http://www.edn.com)]

# EDN<sup>®</sup> productmart

This advertising is  
for new and  
current products.

**HAMEG<sup>®</sup>**  
Instruments  
A Rohde & Schwarz Company

from  
**\$3,765**

**1GHz/3GHz Spectrum Analyzer**  
HMS1000 | HMS1010 | HMS3000 | HMS3010  
with Tracking Generator

**HAPRO Electronics**  
Tel: +1-516-794-4080 · [www.hameg.us](http://www.hameg.us)



## Murphy's Law applies— even under water



One of the most ambitious projects I ever worked on was the inspection of a hydroelectric feed tunnel through the Andes in Peru. The principal tool was a specially designed ROV (remotely operated vehicle), which swam through the tunnel, taking measurements. All ROVs function in much the same way. They connect using an electrical umbilical cable, which carries power and control signals from the surface. There, the umbilical cable connects to the control console at which the operator has joysticks to drive the vehicle and a video monitor to see the image it sends back. ROVs often carry more than one videocamera and a selection of other accessories, including a depth gauge, a compass, lights, and sonars. Most have an umbilical connector a few hundred, or thousand, feet long. Because of the tunnel length, this one was an exceptional 10 km long.

Because of a drop-dead development deadline, we arrived in Peru before the final testing of the manipulator. It had performed fine over a test cable, and we didn't anticipate any problems. A classic Murphy's Law scenario ensued. I now know better: Get Murphy underwater, and he goes on steroids.

The only difference, we thought, between the test cable and the umbilical connection was that the umbilical cable

carried the serial link over an optic fiber. The main ROV control used an identical link, which performed flawlessly during trials. However, when we tried the RS-232-link-controlled manipulator, it refused to work. I could see the RS-232 signals as they left the optical converter in the ROV, but the arm didn't respond. Looking at the manipulator electronics, I found that the TTL output from the RS-232 level shifter didn't move from

ground. Clearly, the level-shifter chip was faulty, so I replaced it—but with the same results. The output seemed nailed to ground. I checked for a short in the PCB, but the trace was fine.

In desperation, I shut the system down so I could watch it come to life. I found a curious phenomenon. As I sent the first commands to the manipulator, I could see a few good pulses on the “bad” pin, but then saw nothing. This situation suggested another explanation. You can set most microcontroller I/O pins as input or output. Suppose that the microcontroller had been changing the pin in question to output mode and setting it low? In that case, it would explain what we were seeing. When two TTL signals argue, the low side always wins.

I was on top of a mountain in Peru, with a shaky telephone link and a significant time difference, but I called the Scottish company that had manufactured the manipulator and managed to speak to one of the engineers familiar with the code. I asked whether he could provide a small software patch that would force the bad pin to input mode on every program cycle, about 10 times a second. He called back with a single line of code for us. Fortunately, I had an EPROM eraser and a programmer with me and was able to insert the code.

On testing, we at last saw some activity from the arm. Again, I spoke to the engineer in Scotland, asking for a more comprehensive code revision. He came back with a version he said should fix the problem. It was four pages of hex code that we would somehow have to get into the programmer. Scotland faxed it to our office in Lima, where someone read it to us over the phone. I took the four pages of handwritten hex characters and carefully entered them into the EPROM programmer.

We put the EPROM back into the manipulator, and the system powered up. With all of us holding our breaths, I pushed the manipulator joystick, and the arm worked! **EDN**

This Tale is a runner-up in EDN's Tales from the Cube: Tell Us Your Tale contest, sponsored by Tektronix. Read the other finalists' entries at [http://bit.ly/Talesfinal\\_EDN](http://bit.ly/Talesfinal_EDN).

# From extreme value to extreme performance.



## Infiniium 9000 Series

- 600 MHz- 4 GHz
- MSO and DSO models
- 20 GSa/s sample rate
- 40 Mpts memory std. (optional to 1 Gpt)
- >30 protocol, compliance and analysis options

Whether you need the fastest real-time oscilloscope on earth with the highest measurement accuracy anywhere, or something a little more basic, from 20 MHz to 90 GHz Agilent oscilloscopes outperform in every category. That's why discerning engineers have made Agilent the fastest growing oscilloscope company in the world since 1997. Like you, we're working on what's next.

**That's thinking ahead. That's Agilent.**



Scan code or visit  
<http://goo.gl/NR3Xm> for  
9000 Series demo video

Explore the Infiniium 9000 Series.

Read our app note for scope-based protocol analysis tips.  
[www.agilent.com/find/9000seriesscopes](http://www.agilent.com/find/9000seriesscopes)



# Pure DC

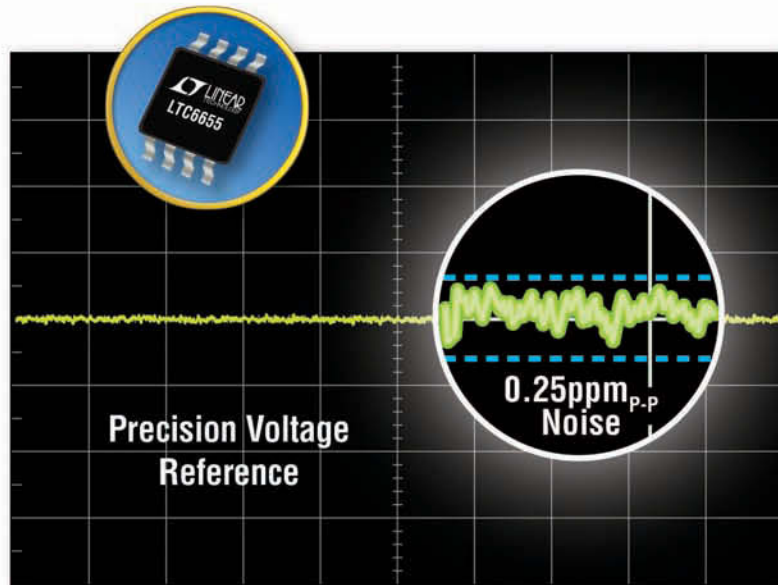

## Announcing the Industry's Lowest Noise, Complete Voltage Reference Family

A lot of noise is made about precision voltage references. At Linear Technology, we're taking the quiet approach—introducing the LTC<sup>®</sup>6655 precision reference, with less than *0.25ppm* of low frequency noise. And if that is not enough, the LTC6655 exhibits less than 2ppm/°C of drift and an initial accuracy within ±0.025%. Such rock solid, pure DC performance ensures that the LTC6655 will be the new standard for high performance instrumentation and test equipment.

### ▼ Features

- Low Noise: 0.25ppm<sub>P-P</sub> (0.1Hz to 10Hz)
- ±0.025% Accuracy, 2ppm/°C Drift
- Fully Specified from -40°C to 125°C, & 100% Tested at -40°C, 25°C and 125°C
- Sinks and Sources Current: ±5mA
- V<sub>S</sub>: 500mV Dropout to 13.2V
- Load Regulation: 3ppm/mA
- Low Power Shutdown: <20μA
- 1.25V, 2.048V, 2.5V, 3V, 3.3V, 4.096V, 5V
- 8-Lead MSOP Package

### Temperature Drift

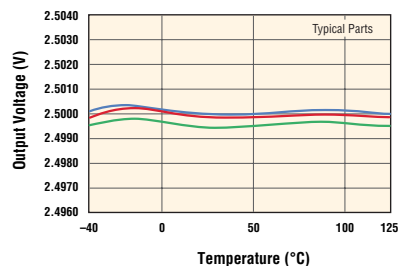

### ▼ Info & Free Samples

[www.linear.com/6655](http://www.linear.com/6655)

1-800-4-LINEAR



[www.linear.com/an124](http://www.linear.com/an124)

L<sup>T</sup>, LTC, LT, LTM and μModule are registered trademarks of Linear Technology Corporation. All other trademarks are the property of their respective owners.

